

M3N WS

ASUS[®]

Motherboard

E3772

First Edition

June 2008

Copyright © 2008 ASUSTeK COMPUTER INC. All Rights Reserved.

No part of this manual, including the products and software described in it, may be reproduced, transmitted, transcribed, stored in a retrieval system, or translated into any language in any form or by any means, except documentation kept by the purchaser for backup purposes, without the express written permission of ASUSTeK COMPUTER INC. ("ASUS").

Product warranty or service will not be extended if: (1) the product is repaired, modified or altered, unless such repair, modification or alteration is authorized in writing by ASUS; or (2) the serial number of the product is defaced or missing.

ASUS PROVIDES THIS MANUAL "AS IS" WITHOUT WARRANTY OF ANY KIND, EITHER EXPRESS OR IMPLIED, INCLUDING BUT NOT LIMITED TO THE IMPLIED WARRANTIES OR CONDITIONS OF MERCHANTABILITY OR FITNESS FOR A PARTICULAR PURPOSE. IN NO EVENT SHALL ASUS, ITS DIRECTORS, OFFICERS, EMPLOYEES OR AGENTS BE LIABLE FOR ANY INDIRECT, SPECIAL, INCIDENTAL, OR CONSEQUENTIAL DAMAGES (INCLUDING DAMAGES FOR LOSS OF PROFITS, LOSS OF BUSINESS, LOSS OF USE OR DATA, INTERRUPTION OF BUSINESS AND THE LIKE), EVEN IF ASUS HAS BEEN ADVISED OF THE POSSIBILITY OF SUCH DAMAGES ARISING FROM ANY DEFECT OR ERROR IN THIS MANUAL OR PRODUCT.

SPECIFICATIONS AND INFORMATION CONTAINED IN THIS MANUAL ARE FURNISHED FOR INFORMATIONAL USE ONLY, AND ARE SUBJECT TO CHANGE AT ANY TIME WITHOUT NOTICE, AND SHOULD NOT BE CONSTRUED AS A COMMITMENT BY ASUS. ASUS ASSUMES NO RESPONSIBILITY OR LIABILITY FOR ANY ERRORS OR INACCURACIES THAT MAY APPEAR IN THIS MANUAL, INCLUDING THE PRODUCTS AND SOFTWARE DESCRIBED IN IT.

Products and corporate names appearing in this manual may or may not be registered trademarks or copyrights of their respective companies, and are used only for identification or explanation and to the owners' benefit, without intent to infringe.

Contents

Contents	iii
Notices	vii
Safety information	viii
About this guide	ix
M3N WS specifications summary	xi
Chapter 1: Product introduction	
1.1 Welcome!	1-1
1.2 Package contents	1-1
1.3 Special features	1-2
1.3.1 Product highlights	1-2
1.3.2 ASUS unique features	1-4
1.3.3 ASUS intelligent performance and overclocking features	1-6
Chapter 2: Hardware information	
2.1 Before you proceed	2-1
2.2 Motherboard overview	2-2
2.2.1 Motherboard layout	2-2
2.2.2 Layout contents	2-3
2.2.3 Placement direction	2-4
2.2.4 Screw holes	2-4
2.3 Central Processing Unit (CPU)	2-5
2.3.1 Installing the CPU	2-5
2.3.2 Installing the heatsink and fan	2-7
2.4 System memory	2-10
2.4.1 Overview	2-10
2.4.2 Memory configurations	2-11
2.4.3 Installing a DDR2 DIMM	2-16
2.4.4 Removing a DDR2 DIMM	2-16
2.5 Expansion slots	2-17
2.5.1 Installing an expansion card	2-17
2.5.2 Configuring an expansion card	2-17
2.5.3 Interrupt assignments	2-18
2.5.4 PCI slots	2-19
2.5.5 PCI-X slot	2-19

Contents

2.5.6	PCI Express x1 slots.....	2-19
2.5.7	PCI Express 2.0 x16 slot.....	2-19
2.6	Jumpers	2-21
2.7	Connectors	2-23
2.7.1	Rear panel connectors.....	2-23
2.7.2	Internal connectors	2-26
2.8	G.P. Diagnosis card installation.....	2-38
2.8.1	G.P. Diagnosis card layout.....	2-38
2.8.2	Installing G.P. Diagnosis card	2-38
2.8.3	G.P. Diagnosis card check codes.....	2-39
2.9	Starting up for the first time.....	2-41
2.10	Turning off the computer.....	2-42
2.10.1	Using the OS shut down function.....	2-42
2.10.2	Using the dual function power switch.....	2-42
 Chapter 3: BIOS setup		
3.1	Managing and updating your BIOS	3-1
3.1.1	ASUS Update utility	3-1
3.1.2	Creating a bootable floppy disk.....	3-4
3.1.3	ASUS EZ Flash 2 utility.....	3-5
3.1.4	Updating the BIOS	3-6
3.1.5	Saving the current BIOS file.....	3-8
3.1.6	ASUS CrashFree BIOS 3 utility	3-9
3.2	BIOS setup program	3-11
3.2.1	BIOS menu screen.....	3-12
3.2.2	Menu bar.....	3-12
3.2.3	Legend bar.....	3-13
3.2.4	Menu items	3-13
3.2.5	Sub-menu items.....	3-13
3.2.6	Configuration fields	3-13
3.2.7	Pop-up window	3-14
3.2.8	General help	3-14
3.3	Main menu	3-15
3.3.1	System Time	3-15
3.3.2	System Date	3-15
3.3.3	Language.....	3-15

Contents

3.3.4	Legacy Diskette A	3-15
3.3.5	Primary IDE Master/Slave.....	3-16
3.3.6	SATA1/2/3/4	3-18
3.3.7	HDD SMART Monitoring.....	3-19
3.3.8	Installed Memory.....	3-19
3.3.9	Usable Memory.....	3-19
3.4	Advanced menu	3-20
3.4.1	JumperFree Configuration	3-20
3.4.2	Ai Net 2	3-22
3.4.3	CPU Configuration	3-22
3.4.4	Chipset.....	3-25
3.4.5	PCIPnP	3-27
3.4.6	Onboard Device Configuration.....	3-28
3.4.7	USB Configuration	3-30
3.5	Power menu.....	3-31
3.5.1	ACPI Suspend Type.....	3-31
3.5.2	ACPI APIC Support.....	3-31
3.5.3	APM Configuration.....	3-31
3.5.4	Hardware Monitor	3-33
3.6	Boot menu	3-35
3.6.1	Boot Device Priority	3-35
3.6.2	Removable Drives.....	3-35
3.6.3	Boot Settings Configuration	3-36
3.6.4	Security	3-37
3.7	Tools menu	3-39
3.7.1	ASUS O.C. Profile.....	3-39
3.7.2	ASUS EZ Flash 2.....	3-41
3.8	Exit menu.....	3-42
 Chapter 4: Software support		
4.1	Installing an operating system	4-1
4.2	Support DVD information	4-1
4.2.1	Running the support DVD	4-1
4.2.2	Drivers menu.....	4-2
4.2.3	Utilities menu	4-3
4.2.4	Make Disk menu	4-5

Contents

- 4.2.5 Manual menu 4-6
- 4.2.6 ASUS Contact information 4-6
- 4.2.7 Other information 4-7
- 4.3 Software information 4-9**
 - 4.3.1 ASUS MyLogo2™ 4-9
 - 4.3.2 Cool 'n' Quiet!™ Technology 4-11
 - 4.3.3 Audio configurations 4-14
 - 4.3.4 ASUS PC Probe II..... 4-22
 - 4.3.5 ASUS AI Suite..... 4-28
 - 4.3.6 ASUS AI Gear 2..... 4-30
 - 4.3.7 ASUS AI Nap 4-31
 - 4.3.8 ASUS AI N.O.S. 4-32
 - 4.3.9 ASUS Q-Fan 2..... 4-33
 - 4.3.10 ASUS AI Booster..... 4-34
- 4.4 RAID configurations 4-35**
 - 4.4.1 RAID definitions 4-35
 - 4.4.2 NVIDIA® RAID configurations..... 4-36
- 4.5 Creating a RAID driver disk..... 4-43**
 - 4.5.1 Creating a RAID driver disk without entering the OS.... 4-43
 - 4.5.2 Creating a RAID/SATA driver disk in Windows®..... 4-43
- Chapter 5: NVIDIA® Hybrid SLI™ technology support**
 - 5.1 NVIDIA® Hybrid SLI® Technology 5-1**
 - 5.1.1 System requirements 5-1
 - 5.1.2 Enabling GeForce® Boost and HybridPower™ 5-2

Notices

Federal Communications Commission Statement

This device complies with Part 15 of the FCC Rules. Operation is subject to the following two conditions:

- This device may not cause harmful interference, and
- This device must accept any interference received including interference that may cause undesired operation.

This equipment has been tested and found to comply with the limits for a Class B digital device, pursuant to Part 15 of the FCC Rules. These limits are designed to provide reasonable protection against harmful interference in a residential installation. This equipment generates, uses and can radiate radio frequency energy and, if not installed and used in accordance with manufacturer's instructions, may cause harmful interference to radio communications. However, there is no guarantee that interference will not occur in a particular installation. If this equipment does cause harmful interference to radio or television reception, which can be determined by turning the equipment off and on, the user is encouraged to try to correct the interference by one or more of the following measures:

- Reorient or relocate the receiving antenna.
- Increase the separation between the equipment and receiver.
- Connect the equipment to an outlet on a circuit different from that to which the receiver is connected.
- Consult the dealer or an experienced radio/TV technician for help.



The use of shielded cables for connection of the monitor to the graphics card is required to assure compliance with FCC regulations. Changes or modifications to this unit not expressly approved by the party responsible for compliance could void the user's authority to operate this equipment.

Canadian Department of Communications Statement

This digital apparatus does not exceed the Class B limits for radio noise emissions from digital apparatus set out in the Radio Interference Regulations of the Canadian Department of Communications.

This class B digital apparatus complies with Canadian ICES-003.

Safety information

Electrical safety

- To prevent electrical shock hazard, disconnect the power cable from the electrical outlet before relocating the system.
- When adding or removing devices to or from the system, ensure that the power cables for the devices are unplugged before the signal cables are connected. If possible, disconnect all power cables from the existing system before you add a device.
- Before connecting or removing signal cables from the motherboard, ensure that all power cables are unplugged.
- Seek professional assistance before using an adapter or extension cord. These devices could interrupt the grounding circuit.
- Make sure that your power supply is set to the correct voltage in your area. If you are not sure about the voltage of the electrical outlet you are using, contact your local power company.
- If the power supply is broken, do not try to fix it by yourself. Contact a qualified service technician or your retailer.

Operation safety

- Before installing the motherboard and adding devices on it, carefully read all the manuals that came with the package.
- Before using the product, make sure all cables are correctly connected and the power cables are not damaged. If you detect any damage, contact your dealer immediately.
- To avoid short circuits, keep paper clips, screws, and staples away from connectors, slots, sockets and circuitry.
- Avoid dust, humidity, and temperature extremes. Do not place the product in any area where it may become wet.
- Place the product on a stable surface.
- If you encounter technical problems with the product, contact a qualified service technician or your retailer.



This symbol of the crossed out wheeled bin indicates that the product (electrical, electronic equipment, and mercury-containing button cell battery) should not be placed in municipal waste. Check local regulations for disposal of electronic products.

About this guide

This user guide contains the information you need when installing and configuring the motherboard.

How this guide is organized

This guide contains the following parts:

- **Chapter 1: Product introduction**
This chapter describes the features of the motherboard and the new technology it supports.
- **Chapter 2: Hardware information**
This chapter lists the hardware setup procedures that you have to perform when installing system components. It includes description of the switches, jumpers, and connectors on the motherboard.
- **Chapter 3: BIOS setup**
This chapter tells how to change system settings through the BIOS Setup menus. Detailed descriptions of the BIOS parameters are also provided.
- **Chapter 4: Software support**
This chapter describes the contents of the support DVD that comes with the motherboard package and the software.
- **Chapter 5: nVIDIA Hybrid SLI™ support**
This chapter describes the nVIDIA Hybrid SLI™ feature and shows the graphics card installation procedures.

Where to find more information

Refer to the following sources for additional information and for product and software updates.

1. **ASUS websites**
The ASUS website provides updated information on ASUS hardware and software products. Refer to the ASUS contact information.
2. **Optional documentation**
Your product package may include optional documentation, such as warranty flyers, that may have been added by your dealer. These documents are not part of the standard package.

Conventions used in this guide

To make sure that you perform certain tasks properly, take note of the following symbols used throughout this manual.



DANGER/WARNING: Information to prevent injury to yourself when trying to complete a task.



CAUTION: Information to prevent damage to the components when trying to complete a task.



IMPORTANT: Instructions that you **MUST** follow to complete a task.



NOTE: Tips and additional information to help you complete a task.

Typography

Bold text

Indicates a menu or an item to select.

Italics

Used to emphasize a word or a phrase.

<Key>

Keys enclosed in the less-than and greater-than sign means that you must press the enclosed key.

Example: <Enter> means that you must press the Enter or Return key.

<Key1+Key2+Key3>

If you must press two or more keys simultaneously, the key names are linked with a plus sign (+).

Example: <Ctrl+Alt+D>

Command

Means that you must type the command exactly as shown, then supply the required item or value enclosed in brackets.

Example: At the DOS prompt, type the command line:

awdf`flash` M3N WS.bin

M3N WS specifications summary

CPU	AMD® Socket AM2/AM2+ for AMD Phenom™ FX / Phenom / Athlon™ / Sempron™ processors AMD Cool 'n' Quiet™ Technology AMD Live!™ Ready Support CPU up to 140W
Chipset	NVIDIA® GeForce® 8200 PCI-X bridge: NEC uPD720404
System Bus	Up to 5200 MT/s; HyperTransport™ 3.0 interface for AM2+ CPU 2000 / 1600 MT/s for AM2 CPU
Memory	Dual-channel memory architecture - 4 x 240-pin DIMM sockets support unbuffered ECC/ non-ECC DDR2 1066*/800/667/533 MHz memory modules - Supports up to 8 GB system memory * Due to AMD CPU limitation, DDR2 1066 is supported by AM2+ CPU for one DIMM per channel only. Refer to www.asus.com or this user manual for the memory QVL (Qualified Vendors Lists). ** When installing total memory of 4GB capacity or more, Windows® 32-bit operation system may only recognize less than 3GB. Hence, a total installed memory of less than 3GB is recommended.
VGA	Integrated NVIDIA® 8 Series GPU - Maximum shared memory of 512MB - Supports HDMI™ Technology with HDCP compliant with max. resolution up to 1920 x 1200 - Supports DVI Technology with max. resolution up to 1920 x 1440 @ 60 Hz - Supports D-Sub with max. resolution up to 1920 x 1440 @ 75 Hz - Multi VGA output support: HDMI/DVI & D-Sub - Hybrid SLI Support (For Windows Vista only)
Expansion Slots	1 x PCIe 2.0 x16 slot at full x16 speed 2 x PCIe x1 slots 1 x PCI-X slot 2 x PCI 2.2 slots
Storage	1 x Ultra DMA 133/100 interface 6 x SATA 3Gb/s ports (Use SATA1-4 for IDE mode) NVIDIA® MediaShield™ RAID supports RAID 0, 1, 0+1, 5, and JBOD
LAN	2 x Realtek® 8111C Gigabit LAN controllers support teaming function

(continued on the next page)

M3N WS specifications summary

High Definition Audio	Realtek® ALC888 8-channel High Definition audio CODEC - Supports Jack-Detection and Multi-Streaming - Coaxial S/PDIF Out port at back I/O
IEEE 1394a	Agere® FW3227 controller supports 2 x IEEE 1394a ports (1 at mid-board; 1 on the rear panel)
USB	12 x USB 2.0 ports (6 at mid-board; 6 on the rear panel)
ASUS AI Lifestyle Unique Features	<p>ASUS Workstation Features:</p> <ul style="list-style-type: none"> - G.P. Diagnosis card - ASUS SASsaby cards support <p>ASUS Power Saving Solution:</p> <ul style="list-style-type: none"> - ASUS AI Nap - ASUS AI Gear 2 <p>ASUS Quiet Thermal Solution:</p> <ul style="list-style-type: none"> - ASUS Heat-pipe thermal solution - ASUS Q-Fan 2 - ASUS Stack Cool 2 <p>ASUS EZ DIY:</p> <ul style="list-style-type: none"> - ASUS Q-Shield - ASUS Q-Connector - ASUS EZ Flash 2 - ASUS CrashFree BIOS 3
Other Features	ASUS MyLogo 2™ Multi-language BIOS ASUS AI NET 2
Rear panel I/O ports	1 x PS/2 keyboard port (purple) 1 x Coaxial S/PDIF Out port 1 x Optical S/PDIF Out port 1 x HDMI Out port 1 x D-sub Out port 2 x LAN ports (RJ-45) 6 x USB 2.0/1.1 ports 8-channel audio I/O

(continued on the next page)

M3N WS specifications summary

Internal I/O connectors	3 x USB connectors support additional 6 USB ports 1 x Floppy disk drive connector 1 x IDE connector 6 x SATA connectors 1 x CPU Fan connector 2 x Chassis Fan connectors 1 x Power Fan connector 2 x IEEE1394a connectors 1 x Front panel audio connector 1 x Chassis Intrusion connector 1 x CD audio in 1 x 24-pin ATX Power connector 1 x 4-pin ATX 12V Power connector 1 x System Panel (Q-Connector)
BIOS features	8 Mb Flash ROM, Award BIOS, PnP, DMI 2.0, WfM2.0, SM BIOS 2.3
Support DVD contents	Drivers BIOS flash utility under DOS ASUS Update Anti-virus Utility (OEM version)
Form factor	ATX form factor: 12 in x 9.6 in (30.5 cm x 24.5 cm)

*Specifications are subject to change without notice.

This chapter describes the motherboard features and the new technologies it supports.

1 Product introduction

Chapter summary

1

1.1	Welcome!	1-1
1.2	Package contents.....	1-1
1.3	Special features.....	1-2

1.1 Welcome!

Thank you for buying an ASUS® M3N WS motherboard!

The motherboard delivers a host of new features and latest technologies, making it another standout in the long line of ASUS quality motherboards!

Before you start installing the motherboard, and hardware devices on it, check the items in your package with the list below.

1.2 Package contents

Check your motherboard package for the following items.

Motherboard	ASUS M3N WS
I/O module	1 x 2-port USB + 1-port IEEE 1394a module
Cables	2 x 2-port Serial ATA power cable 6 x Serial ATA signal cables 1 x Ultra DMA 133/100 cable 1 x Floppy disk drive cable 1 x HDMI to DVI cable
Accessories	1 x I/O Shield 1 x ASUS Q-Connector Kit (USB, 1394, system panel; Retail version only) 1 x G.P. Diagnosis Card (Retail version only)
Application DVD	ASUS motherboard support DVD
Documentation	User guide



If any of the above items is damaged or missing, contact your retailer.

1.3 Special features

1.3.1 Product highlights

Green ASUS



This motherboard and its packaging comply with the European Union's Restriction on the use of Hazardous Substances (RoHS). This is in line with the ASUS vision of creating environment-friendly and recyclable products/packaging to safeguard consumers' health while minimizing the impact on the environment.

AMD® Socket AM2+ Phenom™ FX / Phenom / Athlon™ / Sempron™ CPU support



This motherboard supports AMD® Socket AM2+ multi-core processors with unique L3 cache and delivers better overclocking capabilities with less power consumption. It features dual-channel DDR2 1066 memory support and accelerates data transfer rate up to 5200MT/s via HyperTransport™ 3.0 based system bus. See page 2-5 for details.

HyperTransport™ 3.0 support



HyperTransport™ 3.0 technology provides 2.6 times more bandwidth than HyperTransport™ 1.0, radically improving system efficiency to create a smoother, faster computing environment.

AMD® Socket AM2 Athlon™ Series / Sempron™ CPU support



This motherboard supports AMD® Socket AM2 Athlon™ Series / Sempron™ processors. It features 2000/1600 MT/s HyperTransport™-based system bus, dual-channel un-buffered DDR2 800 memory support, and AMD® Cool 'n' Quiet™ Technology. See page 2-5 for details.

NVIDIA® GeForce 8200



NVIDIA® GeForce 8200 offers the latest support of Hybrid SLI Technology, DirectX® 10 graphics features, HD video playback with HDMI/DVI output. It also supports HyperTransport™ 3.0 interface, PCI Express™ 2.0 bus architecture, Serial ATA 3 Gb/s devices and is optimized with AMD's latest AM2+ and multi-core CPUs to provide excellent system performance.

Native DDR2 1066 support



This motherboard is the first AMD® platform with native DDR2 1066 support. It provides faster data transfer rate and more bandwidth to increase memory computing efficiency, enhancing system performance in 3D graphics and other memory demanding applications. See page 2-10 for details.



DDR2 1066 is supported by AM2+ CPUs only.

NVIDIA® Hybrid SLI Technology



Hybrid SLI™ Technology is a unique hybrid multi-GPU technology. It includes two primary features: GeForce Boost and HybridPower™. GeForce Boost turbo-charges performance of discrete graphics cards when combined with M3N series motherboard GPUs. HybridPower™ unleashes graphics performance for demanding 3D applications and enables low-power operation for everyday computing needs. You can switch from the discrete GeForce GPU(s) to the motherboard GPU for a quiet, low power PC experience. See page 2-20 and Chapter 5 for details.



GeForce Boost and HybridPower™ are independent on select GeForce GPUs. Visit www.nvidia.com/hybridSLI for more information.

HDMI/DVI/D-Sub Interface



HDMI (High-Definition Multimedia Interface) is a set of digital video standards that delivers multi-channel audio and uncompressed digital video through a single cable for full HD 1080p visuals. Supporting HDCP copy protection such as HD DVD and Blu-ray Discs, HDMI provides you with the highest-quality home theater experience.

DVI (Digital Visual Interface) provides high quality visuals for digital display devices like LCD monitors. See page 2-24 for details.



This motherboard is bundled with an HDMI-to-DVI conversion adaptor.

PCIe 2.0 support



This motherboard supports the latest PCIe 2.0 devices for double speed and bandwidth which enhances system performance. See page 2-19 for details.

Serial ATA 3.0 Gb/s technology



This motherboard supports the next-generation hard disk drives based on the Serial ATA (SATA) 3Gb/s storage specifications, delivering enhanced scalability and doubling the bus bandwidth for high-speed data retrieval and save. It allows RAID 0, 1, 0+1 and 5 configurations for two SATA connectors. See page 2-28 for details.

High Definition Audio



Enjoy high-end sound quality on your PC! The onboard 8-channel HD audio (High Definition Audio, previously codenamed Azalia) CODEC enables high-quality 192KHz/24-bit audio output that simultaneously sends different audio streams to different destinations. You can now talk to your partners on the headphones while playing multi-channel network games. See page 2-23 and 2-24 for details.

1.3.2 ASUS unique features

ASUS Power Saving Solution

ASUS Power Saving solution intelligently and automatically provides balanced computing power and energy consumption.

AI Gear 2



AI Gear 2 allows you to choose from profiles to adjust CPU frequency and vCore voltage, minimizing system noise and saving CPU power consumption at most. You can real-time change the mode under operating system to suit your needs. See page 4-30 for details.

AI Nap



With AI Nap, the system can continue running at minimum power and noise when you are temporarily away. To wake the system and return to the OS environment, simply click the mouse or press a key. See page 4-31 for details.

ASUS Workstation Features

ASUS Workstation features provide complete support to system maintenance and storage technology.

G.P. Diagnosis card



Bundled with M3N WS motherboard (retail version), the G.P. Diagnosis card assists users in system checking by effortlessly and quickly providing precise system checks right after they switch on their PCs. See page 2-38 for details.

ASUS SASsaby cards support



This motherboard is fully compatible with ASUS SASsaby cards (optional). Faster, safer and more stable, SAS will provide users with a better choice for storage expansion and upgrade needs. See page 2-20 for details.

ASUS Quiet Thermal Solution

ASUS Quiet Thermal solution makes system more stable and enhances the overclocking capability.

ASUS Stack Cool 2

Stack Cool 2 is a fan-less and zero-noise cooling solution offered exclusively by ASUS. It effectively transfers heat generated by the critical components to the other side of the specially designed PCB (printed circuit board) for effective heat dissipation.

Fanless Design - Heat-pipe

The Heat Pipe design effectively directs the heat generated by the chipsets to the heatsink near the back IO ports, where it can be carried away by existing airflow from CPU fan or bundled optional fan. The purpose of the innovative heat pipe design on this motherboard is that the groundbreaking fanless design does not have lifetime problems as a chipset fan does. Furthermore, it provides options for users to install side-flow fan or passive cooler. The Heat Pipe design is the most reliable fanless thermal solution to date.



DO NOT uninstall the heat-pipe by yourself. Doing so may bend the tubing and affect the heat dissipation performance.

Q-Fan 2

ASUS Q-Fan2 technology intelligently adjusts both CPU fan and chassis fan speeds according to system loading to ensure quiet, cool and efficient operation. See page 3-33 and 4-33 for details.

ASUS EZ DIY

ASUS EZ DIY feature collection provides you easy ways to install computer components, update the BIOS or back up your favorite settings.

ASUS Q-Shield

The specially designed ASUS Q-Shield does without the usual “fingers” — making it convenient and easy to install. With better electric conductivity, it ideally protects your motherboard against static electricity and shields it against Electronic Magnetic Interference (EMI).

ASUS Q-Connector



ASUS Q-Connector allows you to easily connect or disconnect the chassis front panel cables to the motherboard. This unique module eliminates the trouble of connecting the system panel cables one at a time and avoiding wrong cable connections. See page 2-37 for details.

ASUS EZ Flash 2



ASUS EZ Flash 2 is a user-friendly BIOS update utility. Simply press the predefined hotkey to launch the utility and update the BIOS without entering the OS. Update your BIOS easily without preparing a bootable diskette or using an OS-based flash utility. See page 3-5 and 3-41 for details.

ASUS MyLogo 2™



This feature allows you to convert your favorite photo into a 256-color boot logo for a more colorful and vivid image on your screen. See page 3-37 and 4-9 for details.

1.3.3 ASUS intelligent performance and overclocking features

Precision Tweaker



This feature allows you to fine tune the CPU/memory voltage and gradually increase the memory, Front Side Bus (FSB) and PCI Express frequency at 1MHz increment to achieve maximum system performance.

AI Booster

The ASUS AI Booster allows you to overclock the CPU speed in Windows environment without the hassle of booting the BIOS. See page 4-30 for details.

C.P.R. (CPU Parameter Recall)



The C.P.R. feature of the motherboard BIOS allows automatic re-setting to the BIOS default settings in case the system hangs due to overclocking. When the system hangs due to overclocking, C.P.R. eliminates the need to open the system chassis and clear the RTC data. Simply shut down and reboot the system, and the BIOS automatically restores the CPU default setting for each parameter.

This chapter lists the hardware setup procedures that you have to perform when installing system components. It includes description of the jumpers and connectors on the motherboard.

Hardware information

A large, light gray, stylized number '2' is positioned behind the word 'Hardware' in the title.

2.1	Before you proceed	2-1
2.2	Motherboard overview.....	2-2
2.3	Central Processing Unit (CPU)	2-5
2.4	System memory	2-10
2.5	Expansion slots.....	2-17
2.6	Jumpers	2-21
2.7	Connectors	2-23
2.8	G.P. Diagnosis card installation.....	2-38
2.9	Starting up for the first time.....	2-41
2.10	Turning off the computer.....	2-42

2.1 Before you proceed

Take note of the following precautions before you install motherboard components or change any motherboard settings.



- Unplug the power cord from the wall socket before touching any component.
- Use a grounded wrist strap or touch a safely grounded object or to a metal object, such as the power supply case, before handling components to avoid damaging them due to static electricity.
- Hold components by the edges to avoid touching the ICs on them.
- Whenever you uninstall any component, place it on a grounded antistatic pad or in the bag that came with the component.
- Before you install or remove any component, ensure that the ATX power supply is switched off or the power cord is detached from the power supply. Failure to do so may cause severe damage to the motherboard, peripherals, and/or components.

Onboard LED

The motherboard comes with a standby power LED. The green LED lights up to indicate that the system is ON, in sleep mode, or in soft-off mode. This is a reminder that you should shut down the system and unplug the power cable before removing or plugging in any motherboard component. The illustration below shows the location of the onboard LED.

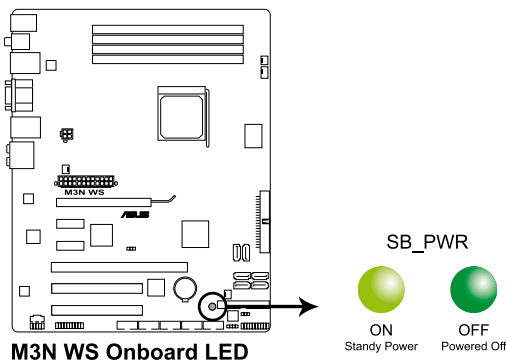

2.2 Motherboard overview

2.2.1 Motherboard layout

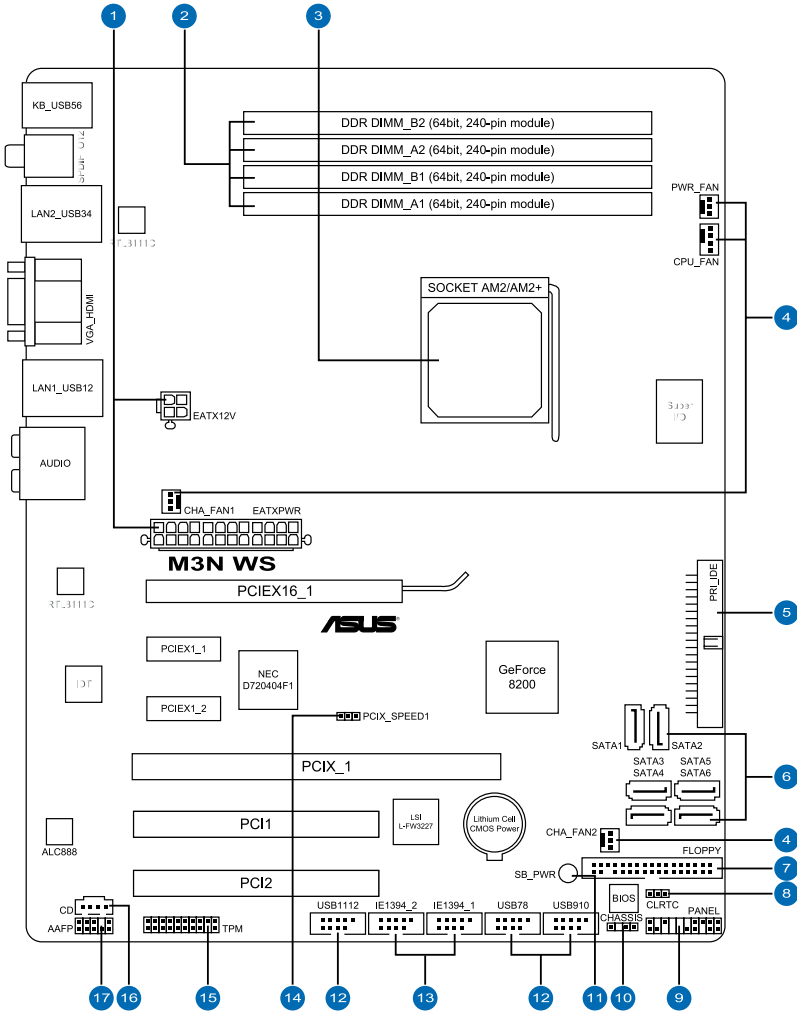

Refer to **2.7 Connectors** for more information about rear panel connectors and internal connectors.

2.2.2 Layout contents

Connectors/Jumpers/Slots		Page
1.	ATX power connectors (24-pin EATXPWR, 4-pin ATX12V)	2-33
2.	DDR2 DIMM slots	2-10
3.	CPU Socket AM2/AM2+	2-5
4.	CPU, chassis, and power fan connectors (4-pin CPU_FAN; 3-pin CHA_FAN1-2; 3-pin PWR_FAN)	2-31
5.	IDE connector (40-1 pin PRI_IDE)	2-27
6.	NVIDIA GeForce 8200 Serial ATA connectors (7-pin SATA 1-4 [red], 7-pin SATA5-6 [black])	2-28
7.	Floppy disk drive connector (34-1 pin FLOPPY)	2-26
8.	Clear RTC RAM (3-pin CLRTC)	2-21
9.	System panel connector (20-8 pin PANEL)	2-36
10.	Chassis intrusion connector (4-1 pin CHASSIS)	2-32
11.	Standby power LED (SB_PWR)	2-1
12.	USB connectors (10-1 pin USB78, USB910, USB1112)	2-29
13.	IEEE 1394a port connectors (10-1 pin IE1394_1, IE1394_2)	2-30
14.	PCI-X speed setting (3-pin PCIX_SPEED1)	2-22
15.	TPM connector (20-1 pin TPM)	2-35
16.	Optical drive audio connector (4-pin CD)	2-32
17.	Front panel audio connector (10-1 pin AAFP)	2-34

2.2.3 Placement direction

When installing the motherboard, make sure that you place it into the chassis in the correct orientation. The edge with external ports goes to the rear part of the chassis as indicated in the image below.

2.2.4 Screw holes

Place nine (9) screws into the holes indicated by circles to secure the motherboard to the chassis.



Do not overtighten the screws! Doing so can damage the motherboard.

Place this side towards the rear of the chassis

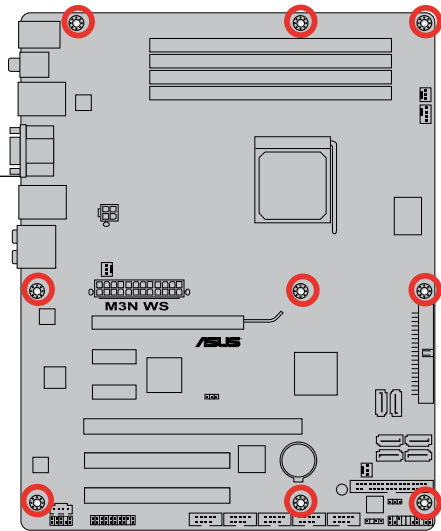

2.3 Central Processing Unit (CPU)

The motherboard comes with an AM2+/AM2 socket designed for AMD® Socket AM2+ Phenom™ FX / Phenom / Athlon™ / Sempron™ processors or for Socket AM2 Athlon series / Sempron processors.



The AM2+/AM2 socket has a different pinout from the 940-pin socket designed for the AMD Opteron processor. Make sure you use a CPU designed for the AM2+/AM2 socket. The CPU fits in only one correct orientation. DO NOT force the CPU into the socket to prevent bending the connectors on the socket and damaging the CPU!

2.3.1 Installing the CPU

To install a CPU:

1. Locate the CPU socket on the motherboard.

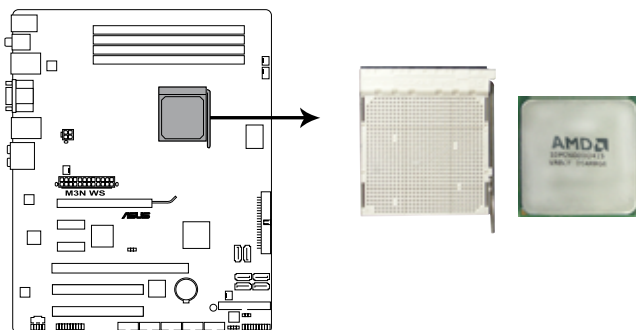

M3N WS CPU socket AM2

2. Unlock the socket by pressing the lever sideways, then lift it up to a 90° angle.

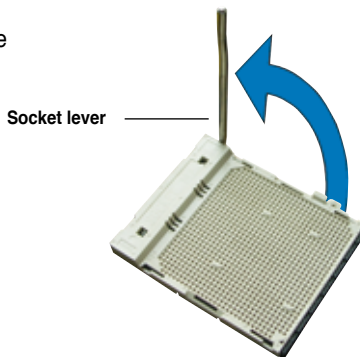

Make sure that the socket lever is lifted up to a 90° angle; otherwise, the CPU will not fit in completely.

3. Position the CPU above the socket such that the CPU corner with the gold triangle matches the socket corner with a small triangle.
4. Carefully insert the CPU into the socket until it fits in place.

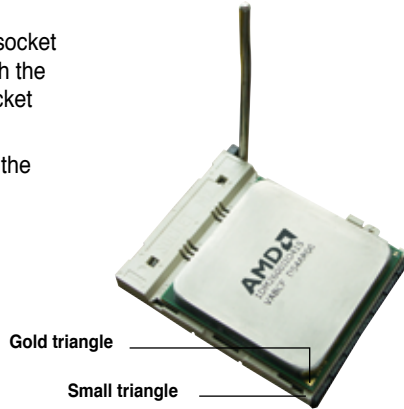

5. When the CPU is in place, push down the socket lever to secure the CPU. The lever clicks on the side tab to indicate that it is locked.
6. Install a CPU heatsink and fan following the instructions that came with the heatsink package.



2.3.2 Installing the heatsink and fan

The AMD® Phenom™ FX / Phenom / Athlon™ / Sempron™ processor requires a specially designed heatsink and fan assembly to ensure optimum thermal condition and performance.



Make sure that you use only AMD-certified heatsink and fan assembly.

To install the CPU heatsink and fan:

1. Place the heatsink on top of the installed CPU, making sure that the heatsink fits properly on the retention module base.



- The retention module base is already installed on the motherboard upon purchase.
 - You do not have to remove the retention module base when installing the CPU or installing other motherboard components.
 - If you purchased a separate CPU heatsink and fan assembly, make sure that a Thermal Interface Material is properly applied to the CPU heatsink or CPU before you install the heatsink and fan assembly.
-

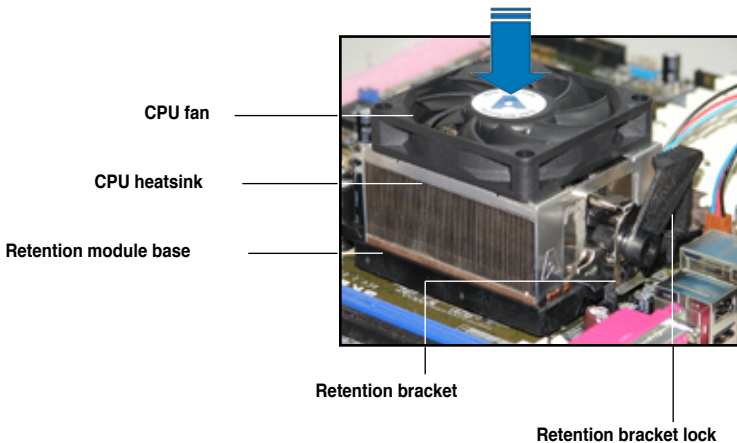

Your boxed CPU heatsink and fan assembly should come with installation instructions for the CPU, heatsink, and the retention mechanism. If the instructions in this section do not match the CPU documentation, follow the latter.

2. Attach one end of the retention bracket to the retention module base.

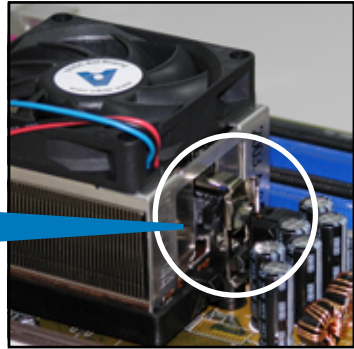
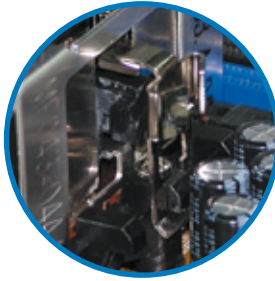

3. Align the other end of the retention bracket (near the retention bracket lock) to the retention module base. A clicking sound denotes that the retention bracket is in place.



Make sure that the fan and heatsink assembly perfectly fits the retention mechanism module base, otherwise you cannot snap the retention bracket in place.

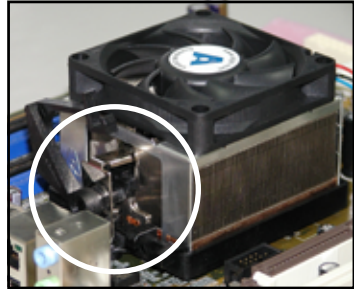

4. Push down the retention bracket lock on the retention mechanism to secure the heatsink and fan to the module base.

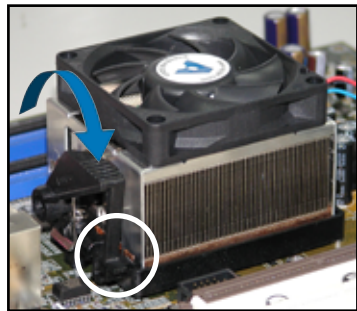

5. When the fan and heatsink assembly is in place, connect the CPU fan cable to the connector on the motherboard labeled CPU_FAN.

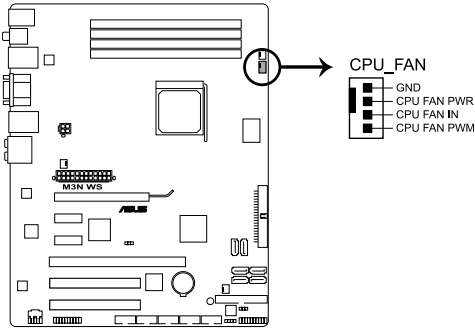

M3N WS CPU fan connector



- Do not forget to connect the CPU fan connector! Hardware monitoring errors can occur if you fail to plug this connector.
- This connector is backward compatible with 3-pin CPU fans .

2.4 System memory

2.4.1 Overview

The motherboard comes with four Double Data Rate 2 (DDR2) Dual Inline Memory Modules (DIMM) sockets.

A DDR2 module has the same physical dimensions as a DDR DIMM but has a 240-pin footprint compared to the 184-pin DDR DIMM. DDR2 DIMMs are notched differently to prevent installation on a DDR DIMM socket.

The figure illustrates the location of the DDR2 DIMM sockets:

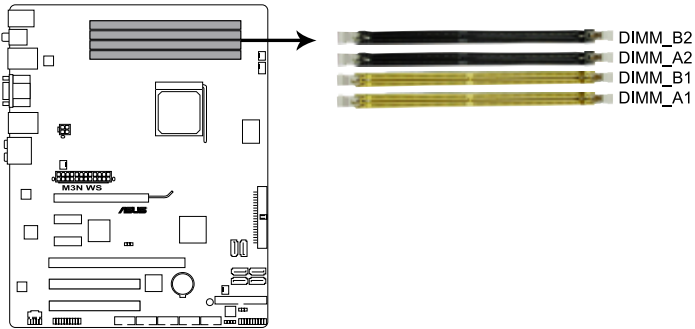

M3N WS 240-pin DDR2 DIMM sockets

Channel	Sockets
Channel A	DIMM_A1 and DIMM_A2
Channel B	DIMM_B1 and DIMM_B2

2.4.2 Memory configurations

You may install 512 MB, 1 GB, and 2 GB unbuffered ECC and non-ECC DDR2 DIMMs into the DIMM sockets.

Recommended Memory Configurations

Mode	Sockets			
	DIMM_A1 (yellow)	DIMM_A2 (black)	DIMM_B1 (yellow)	DIMM_B2 (black)
Single-Channel	–	–	Populated	–
	Populated	–	–	–
Dual-channel (1)	Populated	–	Populated	–
Dual-channel (2)	Populated	Populated	Populated	Populated



- You may install varying memory sizes in Channel A and Channel B. The system maps the total size of the lower-sized channel for the dual-channel configuration. Any excess memory from the higher-sized channel is then mapped for single-channel operation.
- Always install DIMMs with the same CAS latency. For optimum compatibility, it is recommended that you obtain memory modules from the same vendor.
- If you install four 1 GB memory modules, the system may only recognize less than 3GB because the address space is reserved for other critical functions. This limitation appears on Windows® XP/Vista 32-bit operation system which does not support Physical Address Extension (PAE).
- If you install Windows® XP/Vista 32-bit operation system, a total memory of less than 3GB is recommended.
- This motherboard does not support memory modules made up of 128 Mb chips.



Due to OS limitation, this motherboard can only support up to 8 GB on the operating systems listed below. You may install a maximum of 2 GB DIMMs on each slot.

64-bit

Windows® XP Professional x64 Edition
Windows® Vista x64 Edition

M3N WS Motherboard Qualified Vendors Lists (QVL) DDR2-800MHz capability for AM2 CPU

Vendor	Part No.	Size	SS/ DS	Chip No.	CL	Chip Brand	DIMM socket support (Optional)		
							A*	B*	C*
A-DATA	M2OAD6G3H3160G1E53	512MB	SS	AD29608A8A-25EG	N/A	N/A	.	.	.
A-DATA	M2OAD6G3J41701E58	1GB	DS	AD26908A8A-25EG	N/A	N/A	.	.	.
A-DATA	M2OAD6H3J4171Q1E52	2GB	DS	AD20908A8A-25EG	N/A	N/A	A-DATA	.	.
Apacer	78.91G9I.9K5	512MB	SS	AM4B5708JQS8E	N/A	APACER	.	.	.
Apacer	78.01GA0.9K5	1GB	SS	AM4B5908CQJS8E	N/A	APACER	.	.	.
Apacer	78.A1GA0.9K4	2GB	DS	AM4B5908CQJS8E	5	APACER	.	.	.
CORSAIR	CM2X1024-6400C4	1GB	DS	Heat-Sink Package	4	N/A	.	.	.
Crucial	BL12864AA804.16FD	1GB	DS	Heat-Sink Package	4	N/A	.	.	.
Crucial	BL12864AL804.16FD3	1GB	DS	Heat-Sink Package	4	N/A	.	.	.
Crucial	BL12864AA804.16FD3	1GB	DS	Heat-Sink Package	4	N/A	.	.	.
ELPIDA	EBE10EE8ABFA-8E-E	1GB	SS	E1108AB-8E-E(ECC)	5	ELPIDA	.	.	.
G.SKILL	F2-6400CL4D-2GBPK	1GB	DS	Heat-Sink Package	N/A	N/A	.	.	.
G.SKILL	F2-6400PHUJ2-2GBNR	1GB	DS	Heat-Sink Package	N/A	N/A	.	.	.
G.SKILL	F2-6400CL4D-4GBPK	4GB (Kit of 2)	DS	Heat-Sink Package	4	N/A	.	.	.
G.SKILL	F2-6400CL5D-4GBPQ	4GB (Kit of 2)	DS	Heat-Sink Package	5	N/A	.	.	.
GEIL	Heat-Sink Package	2GB	DS	GE24GB800C5DC	5-5-5-15	N/A	.	.	.
GEIL	Heat-Sink Package	2GB	DS	GE28GB800C5QC	5-5-5-15	N/A	.	.	.
GEIL	Heat-Sink Package	2GB	DS	GE28GB800C4QC	4-4-4-12	N/A	.	.	.
GEIL	Heat-Sink Package	2GB	DS	GE24GB800C4DC	4-4-4-12	N/A	.	.	.
GEIL	GL2L128M88BA25AB	2GB	DS	GB24GB6400C5DC	5-5-5-15	GEIL	.	.	.
Hynix	HYMP564U64CP8-S5	512MB	SS	HY5PS12821CFP-S5	5-5-5	Hynix	.	.	.
Hynix	HYMP512U64CP8-S5	1GB	DS	HY5PS12821CFP-S5	5-5-5	Hynix	.	.	.
KINGMAX	KLDC28F-A8KI5	512MB	SS	KK48FEIBF-HJK-25A	N/A	KINGMAX	.	.	.
KINGMAX	KLDD48F-ABKI5	1GB	DS	KK48FEIBF-HJK-25A	N/A	KINGMAX	.	.	.
KINGMAX	KLDE88F-88KB5	2GB	DS	KK88FFBFX-CFA-25A	N/A	KINGMAX	.	.	.
KINGSTON	KVR800D2N5/512	512MB	SS	E5108AJBG-8E-E	N/A	ELPIDA	.	.	.
KINGSTON	KVR800D2N6/512	512MB	SS	E5108AJBG-8E-E	1.8	ELPIDA	.	.	.
KINGSTON	KHX6400D2LLK2/ 1GN(EPP)	1GB	SS	Heat-Sink Package	4-4-4-12	N/A	.	.	.
KINGSTON	KHX6400D2ULK2/1G	1GB	SS	Heat-Sink Package	N/A	N/A	.	.	.
KINGSTON	KVR800D2N5/1G	1GB	DS	V59C1512804QBF25	N/A	N/A	.	.	.
KINGSTON	KVR800D2N6/1G	1GB	DS	E5108AJBG-8E-E	1.8	ELPIDA	.	.	.
KINGSTON	KVR800D2N5/2G	2GB	DS	E1108ACBG-8E-E	N/A	ELPIDA	.	.	.
NANYA	NT512T64U880BY-25C	512MB	SS	NT5TU64M8BE-25C	5	NANYA	.	.	.
NANYA	NT1GT64U880BY-25C	1GB	DS	NT5TU64M8BE-25C	5	NANYA	.	.	.
NANYA	NT1GT64U8HCOBY-25D	1GB	DS	NT5TU64M8CE-25D	N/A	NANYA	.	.	.

M3N WS Motherboard Qualified Vendors Lists (QVL) DDR2-800MHz capability for AM2 CPU (continued)

Vendor	Part No.	Size	SS/ DS	Chip No.	CL	Chip Brand	DIMM socket support (Optional)		
							A*	B*	C*
NANYA	NT2GT64U8HC0BY-AC	2GB	DS	NT5TU128M8CE-AC	5	NANYA	.	.	.
OCZ	OCZ2T18002GK	1GB	DS	Heat-Sink Package	N/A	N/A	.	.	.
OCZ	OCZ2FX800C32GK	1GB	DS	Heat-Sink Package	N/A	N/A	.	.	.
OCZ	OCZ2P800R22GK	2GB (Kit of 2)	DS	Heat-Sink Package	4	N/A	.	.	.
OCZ	OCZ2P8004GK	4GB (Kit of 2)	DS	Heat-Sink Package	5-4-4	N/A	.	.	.
PSC	AL8E8F73C-8E1	2GB	DS	A3R1GE3CFF734MAA0E	5	PSC	.	.	.
Qimonda	HYS64T256020EU-25F-C2	2GB	DS	HYB18T1G800C2F-25F	5	QIMONDA	.	.	.
Qimonda	HYS64T256020EU-2.5-C2	2GB	DS	HYB18T1G800C2F-2.5	6	QIMONDA	.	.	.
SAMSUNG	M378T6553GZS-CF7	512MB	SS	K4T51083QG	6	SAMSUNG	.	.	.
SAMSUNG	M378T2863QZS-CF7	1GB	SS	K4T1G084QQ	6	SAMSUNG	.	.	.
SAMSUNG	M391T2863QZ3-CF7	1GB	SS	K4T1G084QQ(ECC)	6	SAMSUNG	.	.	.
SAMSUNG	M378T2953GZ3-CF7	1GB	DS	K4T51083QG	6	SAMSUNG	.	.	.
SAMSUNG	M378T5263AZ3-CF7	4GB	DS	K4T2G084QA-HCF7	6	SAMSUNG	.	.	.
SAMSUNG	M391T5663QZ3-CF7	2GB	DS	K4T1G084QQ	6	SAMSUNG	.	.	.
SAMSUNG	M378T5663QZ3-CF7	2GB	DS	K4T1G084QQ(ECC)	6	SAMSUNG	.	.	.
Super Talent	T800UA12C4	512MB	SS	Heat-Sink Package	N/A	N/A	.	.	.
Super Talent	T800UB1GC4	1GB	DS	Heat-Sink Package	N/A	N/A	.	.	.
Aeneon	AET760UD00-25DC08X	1GB	SS	AET03R25DC	5	Aeneon	.	.	.
Aeneon	AET760UD00-25DB97X	1GB	DS	AET93R25DB	N/A	Aeneon	.	.	.
Aeneon	AET860UD00-25DC08S	2GB	DS	AET02R25DC	N/A	Aeneon	.	.	.
Aeneon	AET860UD00-25DC08X	2GB	DS	AET03R25DC	5	Aeneon	.	.	.
Asint	SLY2128M8-JGE	1GB	SS	DDR11208-GE	N/A	Asint	.	.	.
Asint	SLZ2128M8-JGE	2GB	DS	DDR11208-GE	N/A	Asint	.	.	.
CENTURY	28V2H8	512MB	SS	HY5PS12821BFP-S5	N/A	Hynix	.	.	.
CENTURY	28VOH8	1GB	DS	HY5PS12821BFP-S5	N/A	Hynix	.	.	.
Elixir	M2Y1G64TU8HB0B-25C	1GB	DS	N2TU51280BE-25C	5	Elixir	.	.	.
Oci	04701G16CZ5D2A	1GB	DS	64M8PC6400	5	Infinity	.	.	.
Patriot	PSD21G8002	1GB	DS	PM64M8D2BU-25PAC	5	Patriot	.	.	.
Patriot	PSD22GB002	2GB	DS	PM128M8D2BU-25KC	5	Patriot	.	.	.
UMAX	D48001GP3-63BJU	1GB	DS	U2S12D30TP-8E	N/A	UMAX	.	.	.
UMAX	D48002GP0-73BCU	2GB	DS	U2S12D30TP-8E	N/A	UMAX	.	.	.

M3N WS Motherboard Qualified Vendors Lists (QVL) DDR2-667MHz capability for AM2 CPU

Vendor	Part No.	Size	SS/ DS	Chip No.	CL	Chip Brand	DIMM socket support (Optional)		
							A*	B*	C*
A-DATA	M2OAD5G3H316611C52	512MB	SS	AD29608A8A-3EG	5	A-DATA	•	•	
A-DATA	M2OAD5G3I417611C52	1GB	DS	AD29608A8A-3EG	5	A-DATA	•		
A-DATA	M2ONY5H3J417011C5Z	2GB	DS	NT5TU128M8BJ-3C	N/A	N/A		•	
Apacer	78.01G90.9K5	1GB	SS	AM4B5808CQJS7E	N/A	APACER	•		
Apacer	78.91G92.9K5	512MB	SS	AM4B5708JQJS7E	N/A	APACER	•		
Apacer	78.A1G90.9K4	2GB	DS	AM4B5808CQJS7E	N/A	APACER	•	•	
CORSAIR	VS 512MB667D2	512MB	SS	64M8CFEG	N/A	N/A	•	•	
CORSAIR	VS1GB667D2	1GB	DS	64M8CFEG	N/A	N/A	•	•	
crucial	BL6464AA663.8FD	512MB	SS	Heat-Sink Package	3	N/A	•	•	
crucial	BL12864AA663.16FD	1GB	DS	Heat-Sink Package	3	N/A	•	•	•
ELPIDA	EBE51UD8AEFA-6E-E	512MB	SS	E5108AE-6E-E	5	ELPIDA	•	•	•
G.SKILL	F2-5300CL5D-4GBMQ	4GB (Kit of 2)	DS	Heat-Sink Package	5-5-5-15	N/A	•	•	
G.SKILL	F2-5400PHU2-2GBNT	2GB (Kit of 2)	DS	D264M8GCF	5-5-5-15	G.SKILL	•		•
GEIL	GX21GB5300SX	1GB	DS	Heat-Sink Package	3-4-4-8	N/A	•	•	•
GEIL	GX22GB5300LX	2GB	DS	Heat-Sink Package	5-5-5-15	N/A	•	•	•
GEIL	GX24GB5300LDC	4GB (Kit of 2)	DS	Heat-Sink Package	5-5-5-15	N/A	•	•	•
Hynix	HYMP 512U64CP8-Y5	1GB	DS	HY5PS12821CFP-Y5	5	Hynix	•	•	•
Kingmax	KLCC28F-A8KB5	512MB	SS	KKEA88B4LAUG-29DX	5	KINGMAX	•	•	•
Kingmax	KLCD48F-A8KB5	1GB	DS	KKEA88B4LAUG-29DX	5	KINGMAX			•
KINGSTON	KVR667D2N5/ 512	512MB	SS	D6408TEBGL3U	5	KINGSTON	•	•	
KINGSTON	KVR667D2E5/1G	1GB	DS	E5108AGBG-6E-E	N/A	ELPIDA	•	•	•
KINGSTON	KVR667D2E5/2G	2GB	DS	D9HNL	N/A	MICRON	•	•	•
KINGSTON	KVR667D2N5/1G	1GB	DS	E5108AGBG-6E-E	N/A	KINGSTON	•	•	•
KINGSTON	KVR667D2N5/2G	2GB	DS	E1108AB-6E-E	N/A	ELPIDA	•	•	
KINGSTON	KVR667D2N5/2G	2GB	DS	HY5PS1G831CFP-Y5	N/A	Hynix	•	•	•
NANYA	NT 512T64U88B0BY-3C	512MB	SS	NT5TU64M8BE-3C	5	NANYA	•	•	•
NANYA	NT2GT64U8HB0JY-3C	2GB	DS	NT5TU128M8BJ-3C	5	NANYA	•	•	•
PSC	AL7E8E63J-6E1	1GB	DS	A3R12E3JFF719A9T02	5	PSC	•	•	•
Qimonda	HYS64T256020EU-3S-C2	2GB	DS	HYB18T1GB00C2F-3S	5	QIMONDA	•	•	
SAMSUNG	M378T6533EZ3-CE6	512MB	SS	K4T51083QE	5	SAMSUNG	•	•	
SAMSUNG	M378T2933EZ3-CE6	1GB	DS	K4T51083QE	5	SAMSUNG	•	•	•
SAMSUNG	M378T5263AZ3-CE6	4GB	DS	K4T2G084QA-HCE6	5	SAMSUNG	•	•	
Super Talent	T6UA 512C5	512MB	SS	Heat-Sink Package	5	N/A	•	•	
Super Talent	T6UB1GC5	1GB	DS	Heat-Sink Package	5	N/A	•	•	•
Transcend	JM667QLU-1G	1GB	SS	TQ243ECF8	5	Transcend	•	•	

M3N WS Motherboard Qualified Vendors Lists (QVL) DDR2-667MHz capability for AM2 CPU (continued)

Vendor	Part No.	Size	SS/ DS	Chip No.	CL	Chip Brand	DIMM socket support (Optional)		
							A*	B*	C*
Transcend	JM667QLU-2G	2GB	DS	TQ243ECF8	5	Transcend	.	.	.
TwinMOS	8D-23JK5M2ETP	512MB	SS	TMM6208G8M30C	5	TwinMOS	.	.	.
Aeneon	AET660UD00-30DB97X	512MB	SS	AET93R300B	5	AENEON	.	.	.
Aeneon	AET760UD00-30B97X	1GB	DS	AET93R300B	5	AENEON	.	.	.
Aeneon	AET860UD00-30D	2GB	DS	AET02R30DC	5	AENEON	.	.	.
Aeneon	AET860UD00-30DB08X	2GB	DS	AET03F30DB	5	AENEON	.	.	.
Asint	SLX264M8-J6E	512MB	SS	DDRll6408-6E	N/A	Asint	.	.	.
Asint	SLY2128M8-J6E	1GB	SS	DDRll1208-6E	N/A	Asint	.	.	.
CENTURY	26V2H8	512MB	SS	HY5PS12821CFP-Y5	5	Hynix	.	.	.
CENTURY	26VOH8	1GB	DS	HY5PS12821CFP-Y5	5	Hynix	.	.	.
Kingbox	N/A	1GB	SS	EPD2128082200E-4	N/A	Kingbox	.	.	.
Kingbox	N/A	1GB	DS	EPD264082200E-4	N/A	N/A	.	.	.
Kingbox	N/A	1GB	DS	EPD264082200N-4	N/A	Kingbox	.	.	.
MDT	M 512-667-8	512MB	SS	18D 51280D-30648	4	MDT	.	.	.
MDT	M924-667-16	1GB	DS	18D 51280D-30646E	4	MDT	.	.	.
MDT	M924-667-16A	1GB	DS	18 51200D-30646	4	MDT	.	.	.
Patriot	PSD2 51266781	512MB	SS	PM64M8D2BU-3KC	N/A	N/A	.	.	.
Patriot	PSD21G6672	1GB	DS	PM64M8D2BU-3PAC	5	Patriot	.	.	.
UMAX	D46701GP3-63BJU	1GB	DS	U2S12D30TP-6E	N/A	UMAX	.	.	.
UMAX	D46702GP0-73BCU	2GB	DS	U2S24D30TP-6E	N/A	UMAX	.	.	.



Side(s): SS - Single-sided DS - Double-sided DIMM support:

- **A***: Supports one module inserted into either slot as Single-channel memory configuration.
- **B***: Supports two modules inserted into either the yellow slots or the black slots as one pair of Dual-channel memory configuration.
- **C***: Supports four modules inserted into both the yellow slots and the black slots as two pairs of Dual-channel memory configuration.



Visit the ASUS website for the latest QVL.

2.4.3 Installing a DDR2 DIMM



Make sure to unplug the power supply before adding or removing DIMMs or other system components. Failure to do so may cause severe damage to both the motherboard and the components.

1. Unlock a DDR2 DIMM socket by pressing the retaining clips outward.
2. Align a DIMM on the socket such that the notch on the DIMM matches the break on the socket.

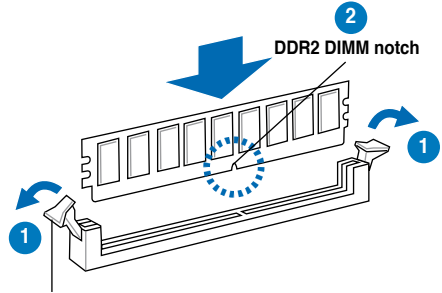

Unlocked retaining clip



A DDR2 DIMM is keyed with a notch so that it fits in only one direction. DO NOT force a DIMM into a socket to avoid damaging the DIMM.

3. Firmly insert the DIMM into the socket until the retaining clips snap back in place and the DIMM is properly seated.

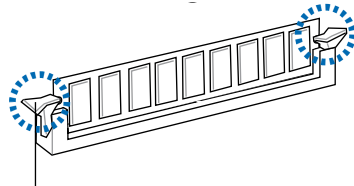

Locked Retaining Clip

2.4.4 Removing a DDR2 DIMM

Follow these steps to remove a DIMM.

1. Simultaneously press the retaining clips outward to unlock the DIMM.

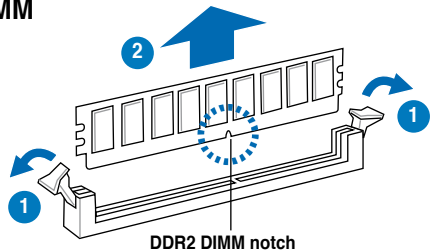

DDR2 DIMM notch



Support the DIMM lightly with your fingers when pressing the retaining clips. The DIMM might get damaged when it flips out with extra force.

2. Remove the DIMM from the socket.

2.5 Expansion slots

In the future, you may need to install expansion cards. The following sub-sections describe the slots and the expansion cards that they support.



Make sure to unplug the power cord before adding or removing expansion cards. Failure to do so may cause you physical injury and damage motherboard components.

2.5.1 Installing an expansion card

To install an expansion card:

1. Before installing the expansion card, read the documentation that came with it and make the necessary hardware settings for the card.
2. Remove the system unit cover (if your motherboard is already installed in a chassis).
3. Remove the bracket opposite the slot that you intend to use. Keep the screw for later use.
4. Align the card connector with the slot and press firmly until the card is completely seated on the slot.
5. Secure the card to the chassis with the screw you removed earlier.
6. Replace the system cover.

2.5.2 Configuring an expansion card

After installing the expansion card, configure the it by adjusting the software settings.

1. Turn on the system and change the necessary BIOS settings, if any. See Chapter 3 for information on BIOS setup.
2. Assign an IRQ to the card. Refer to the tables on the next page.
3. Install the software drivers for the expansion card.



When using PCI cards on shared slots, ensure that the drivers support “Share IRQ” or that the cards do not need IRQ assignments; otherwise, conflicts will arise between the two PCI groups, making the system unstable and the card inoperable.

2.5.3 Interrupt assignments

Standard interrupt assignments

IRQ	Priority	Standard function
0	1	System Timer
1	2	Keyboard Controller
2	–	Redirect to IRQ#9
3	11	Reserved
4	12	Reserved
5	13	IRQ Holder for PCI Steering*
6	14	Floppy Disk Controller
7	15	IRQ Holder for PCI Steering*
8	3	System CMOS/Real Time Clock
9	4	IRQ Holder for PCI Steering*
10	5	IRQ Holder for PCI Steering*
11	6	IRQ Holder for PCI Steering*
12	7	Reserved
13	8	Numeric Data Processor
14	9	Primary IDE Channel

* These IRQs are usually available for ISA or PCI devices.

IRQ assignments for this motherboard

	A	B	C	D	E	F	G	H
PCIe x16_1	shared	shared	shared	shared	–	–	–	–
USB 1.0 controller 1	–	–	–	shared	–	–	–	–
USB 1.0 controller 2	–	–	–	shared	–	–	–	–
USB 1.0 controller 3	–	–	–	shared	–	–	–	–
USB 1.0 controller 4	–	–	–	shared	–	–	–	–
USB 2.0 controller	–	–	–	shared	–	–	–	–
HD audio	shared	–	–	–	–	–	–	–

2.5.4 PCI slots

The PCI slots support cards such as a LAN card, SCSI card, USB card, and other cards that comply with PCI specifications. Refer to the figure on the next page for the location of the slots.

2.5.5 PCI-X slot

The PCI-X slot supports cards such as a LAN card, SCSI card, USB card, and other cards that comply with PCI-X 1.0 specifications. Refer to the figure below for the location of the slot.

2.5.6 PCI Express x1 slots

This motherboard supports PCI Express x1 network cards, SCSI cards and other cards that comply with the PCI Express specifications. Refer to the figure on the next page for the location of the slots.

2.5.7 PCI Express 2.0 x16 slot

This motherboard supports PCI Express 2.0 x16 graphics cards that complies with the PCI Express specifications. Refer to the figure below for the location of the slot.

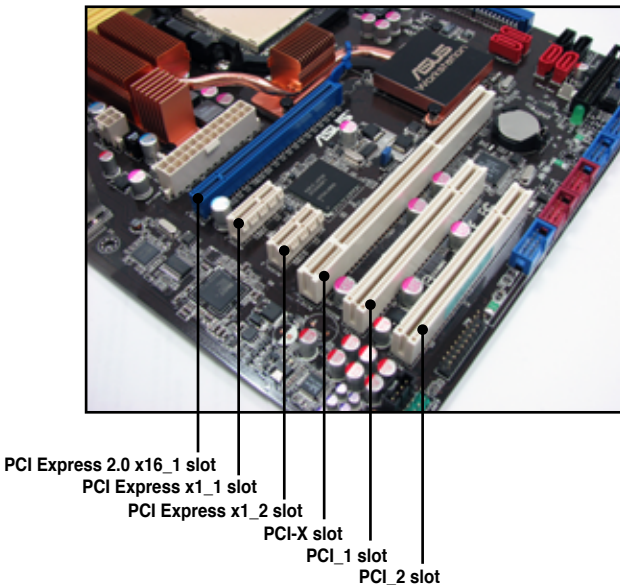



-
- Currently, only Windows® Vista operation system supports Hybrid SLI™ mode.
 - Currently, only NVIDIA® GeForce® 8500 GT and GeForce® 8400 GS graphics cards support GeForce Boost function under Hybrid SLI™ mode.
 - Currently, only NVIDIA® GeForce® 9800 GX2 and GeForce® 9800 GTX graphics cards support Hybrid Power function under Hybrid SLI™ mode.
 - Use only the onboard HDMI/DVI/D-Sub port for video signal output when activating the Hybrid Power function under Hybrid SLI™ mode.
 - Visit www.nvidia.com/hybridsli for more information about Hybrid SLI™ support.
 - This motherboard supports the ASUS SASsaby SAS RAID card series (optional) for SAS hard disk drive expansion. Install the card to the PCIe x16 2.0 slot (blue) only.
-

2.6 Jumpers

1. Clear RTC RAM (3-pin CLRRTC)

This jumper allows you to clear the Real Time Clock (RTC) RAM in CMOS. You can clear the CMOS memory of date, time, and system setup parameters by erasing the CMOS RTC RAM data. The onboard button cell battery powers the RAM data in CMOS, which include system setup information such as system passwords.

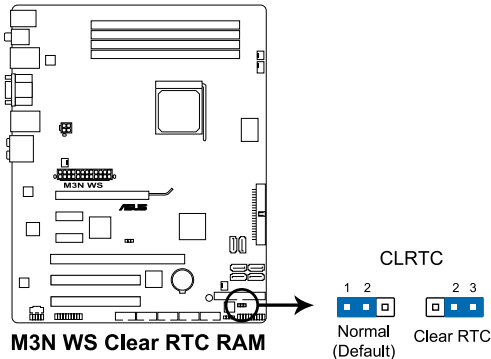

To erase the RTC RAM

1. Turn OFF the computer and unplug the power cord.
2. Move the jumper cap from pins 1-2 (default) to pins 2-3. Keep the cap on pins 2-3 for about 5–10 seconds, then move the cap back to pins 1-2.
3. Plug the power cord and turn ON the computer.
4. Hold down the key during the boot process and enter BIOS setup to re-enter data.



Except when clearing the RTC RAM, never remove the cap on CLRRTC jumper default position. Removing the cap will cause system boot failure!



- If the steps above do not help, remove the onboard battery and move the jumper again to clear the CMOS RTC RAM data. After the CMOS clearance, reinstall the battery.
- You do not need to clear the RTC when the system hangs due to overclocking. For system failure due to overclocking, use the C.P.R. (CPU Parameter Recall) feature. Shut down and reboot the system so the BIOS can automatically reset parameter settings to default values.
- Due to the chipset limitation, AC power off is required prior using C.P.R. function. You must turn off and on the power supply or unplug and plug the power cord before reboot the system.

2. PCI-X Speed setting (3-pin PCI_X_SPEED1)

This jumper allows you to set the PCI-X slot's maximum frequency capability.

The jumper cap on pins 1-2: 133 MHz capability for the PCI-X slot.

The jumper cap on pins 2-3: 100 MHz capability for the PCI-X slot.

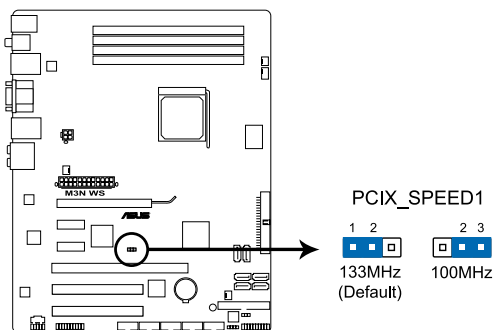

M3N WS PCI-X speed setting

2.7 Connectors

2.7.1 Rear panel connectors

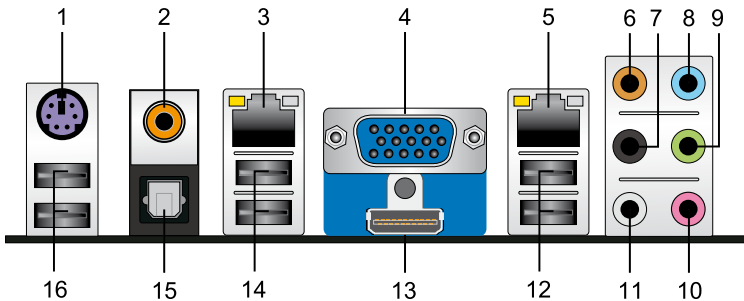

1. **PS/2 keyboard port (purple).** This port is for a PS/2 keyboard.
2. **Coaxial S/PDIF Out port.** This port connects an external audio output device via a coaxial S/PDIF cable.
3. **LAN2 (RJ-45) port.** Supported by Realtek® 8111C Gigabit LAN controller, this port allows Gigabit connection to a Local Area Network (LAN) through a network hub. Refer to the table below for the LAN port LED indications.
4. **VGA port.** This port is for a VGA monitor or other VGA-compatible devices.
5. **LAN1 (RJ-45) port.** Supported by Realtek® 8111C Gigabit LAN controller, this port allows Gigabit connection to a Local Area Network (LAN) through a network hub. Refer to the table below for the LAN port LED indications.

LAN port LED indications

Activity/Link LED		Speed LED	
Status	Description	Status	Description
OFF	No link	OFF	10 Mbps connection
ORANGE	Linked	ORANGE	100 Mbps connection
BLINKING	Data activity	GREEN	1 Gbps connection

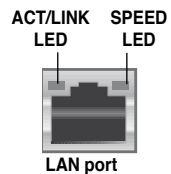

6. **Center/Subwoofer port (orange).** This port connects the center/subwoofer speakers.
7. **Rear Speaker Out port (black).** This port connects the rear speakers in a 4-channel, 6-channel, or 8-channel audio configuration.
8. **Line In port (light blue).** This port connects the tape, CD, DVD player, or other audio sources.
9. **Line Out port (lime).** This port connects a headphone or a speaker. In 4-channel, 6-channel, and 8-channel configuration, the function of this port becomes Front Speaker Out.
10. **Microphone port (pink).** This port connects a microphone.
11. **Side Speaker Out port (gray).** This port connects the side speakers in an 8-channel audio configuration.



Refer to the audio configuration table below for the function of the audio ports in 2, 4, 6, or 8-channel configuration.

Audio 2, 4, 6, or 8-channel configuration

Port	Headset 2-channel	4-channel	6-channel	8-channel
Light Blue	Line In	Line In	Line In	Line In
Lime	Line Out	Front Speaker Out	Front Speaker Out	Front Speaker Out
Pink	Mic In	Mic In	Mic In	Mic In
Orange	–	–	Center/Subwoofer	Center/Subwoofer
Black	–	Rear Speaker Out	Rear Speaker Ou	Rear Speaker Out
Gray	–	–	–	Side Speaker Out

- 12. USB 2.0 ports 1 and 2.** These 4-pin Universal Serial Bus (USB) ports are available for connecting USB 2.0 devices.
- 13. HDMI Out port.** This port is for a high-definition multimedia interface (HDMI) connector.



- This motherboard comes with dual-VGA outputs that features different displays on 2 monitors at the same time if you connect 2 monitors to both the onboard VGA and HDMI ports.
- With the bundled HDMI-to-DVI conversion adapter, this motherboard can also support DVI output.
- **Playback of HD DVD and Blu-Ray Discs**
The speed and bandwidth of the CPU/Memory, DVD player, and drivers will affect the playback quality. Following is a configuration example for your reference. Using the CPU/Memory of higher speed and bandwidth with the higher-version DVD player and drivers will upgrade the playback quality.

CPU: AMD K8 M2 Athlon64 ADH1600IAA5DH/1M Rev.F3
DIMM: DDR2-800 1G x1
HDD: Maxtor 6Y120M0 (SATA150)
ODD: LG GBW-H10N

- To play HD DVD or Blu-Ray Disc, make sure to use an HDCP compliant monitor.



Before enabling the HybridPower™ function, ensure that you have connected your display to the onboard VGA port or the HDMI/DVI port at the rear panel.

- 14. USB 2.0 ports 3 and 4.** These 4-pin Universal Serial Bus (USB) ports are available for connecting USB 2.0 devices.
- 15. Optical S/PDIF Out port.** This port connects an external audio output device via a optical S/PDIF cable.
- 16. USB 2.0 ports 5 and 6.** These 4-pin Universal Serial Bus (USB) ports are available for connecting USB 2.0 devices.

Troubleshooting on HDTV overscaling or underscaling:

If your desktop is extending beyond the viewable display area or the desktop or image is not filling the entire display area while using the onboard HDMI out port and the HDMI cable, you can resize the desktop appearing on your HDTV screen.

To resize your HDTV desktop:

1. Install **NVIDIA Chipset Driver Program** from the motherboard support DVD.
2. Right-click the desktop and select **NVIDIA Control Panel**.
3. Under **Video & Television**, select **Resize HDTV desktop**.
4. Select **Resize my desktop** and click **Resize Desktop**.

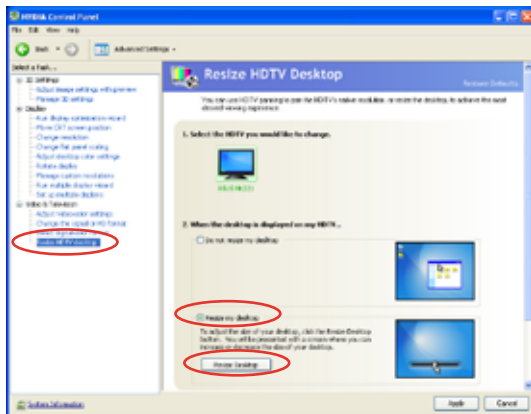

5. A full-screen adjustment tool appears. Use the scroll bar to resize the desktop to fit your display device. Click **OK** to exit.



The **Resize my desktop** function in the NVIDIA Control Panel appears only when you are using an HDTV compliance resolution such as 480i, 720i, or 1080i.

2.7.2 Internal connectors

1. Floppy disk drive connector (34-1 pin FLOPPY)

This connector is for the provided floppy disk drive (FDD) signal cable. Insert one end of the cable to this connector, then connect the other end to the signal connector at the back of the floppy disk drive.



Pin 5 on the connector is removed to prevent incorrect cable connection when using a FDD cable with a covered Pin 5.

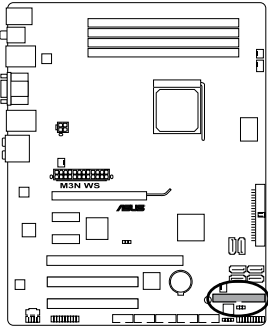

M3N WS Floppy disk drive connector

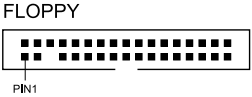

NOTE: Orient the red markings on the floppy ribbon cable to PIN 1.

2. IDE connector (40-1 pin PRI_IDE)

The onboard IDE connector is for the Ultra DMA 133/100 signal cable. There are three connectors on each Ultra DMA 133/100 signal cable: blue, black, and gray. Connect the blue connector to the motherboard's IDE connector, then select one of the following modes to configure your device.

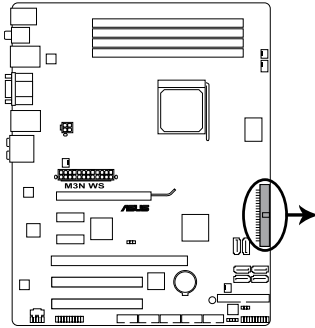

M3N WS IDE connector

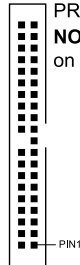

PRI_IDE

NOTE: Orient the red markings on the IDE ribbon cable to PIN 1.

	Drive jumper setting	Mode of device(s)	Cable connector
Single device	Cable-Select or Master	–	Black
Two devices	Cable-Select	Master	Black
		Slave	Gray
	Master	Master	Black or gray
	Slave	Slave	



- Pin 20 on the IDE connector is removed to match the covered hole on the Ultra DMA cable connector. This prevents incorrect insertion when you connect the IDE cable.
- Use the 80-conductor IDE cable for Ultra DMA 133/100 IDE devices.



If any device jumper is set as “Cable-Select,” make sure all other device jumpers have the same setting.

3. NVIDIA® GeForce 8200 Serial ATA connectors (7-pin SATA1-4 [red], 7-pin SATA5-6 [black])

These connectors are for the Serial ATA signal cables for Serial ATA hard disk and optical disk drives.

If you install SATA hard disk drives to the SATA connectors, you can create a RAID 0, RAID 1, RAID 0+1, RAID 5, or JBOD configuration through the onboard NVIDIA® GeForce 8200 controller.

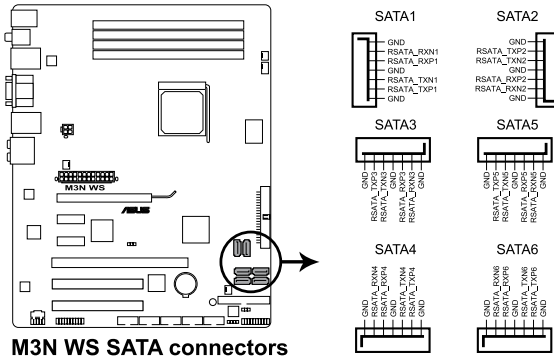

M3N WS SATA connectors



- SATA1-4 connectors are set to [IDE] by default. If you intend to create a Serial ATA RAID set using these connectors, set the **SATA Operation Mode** item in the BIOS to [RAID].
- Before creating a RAID set, refer to the manual bundled in the motherboard support DVD.



- SATA 5-6 connectors support AHCI mode and RAID mode only. Make sure to install the AHCI driver or RAID driver in the bundled support DVD before connecting devices to SATA 5-6 connectors. Otherwise, the devices will not work.
- Due to chipset limitation, when set any of SATA ports to RAID mode, all SATA ports run at RAID mode together.
- You must install the Windows XP® Service Pack 1 before using Serial ATA hard disk drives. The Serial ATA RAID feature (RAID 0 and RAID 1) is available only if you are using Windows XP® or later version.



Connect the right-angle side of SATA signal cable to SATA device. Or you may connect the right-angle side of SATA cable to the onboard SATA port to avoid mechanical conflict with huge graphics cards.

Right angle side

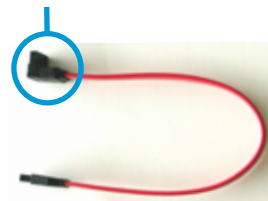

4. USB connectors (10-1 pin USB 78, USB910, USB1112)

These connectors are for USB 2.0 ports. Connect the USB module cable to any of these connectors, then install the module to a slot opening at the back of the system chassis. These USB connectors comply with USB 2.0 specification that supports up to 480 Mbps connection speed.

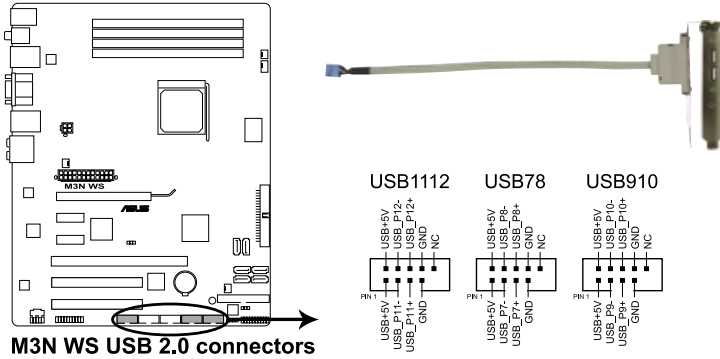

Never connect a 1394 cable to the USB connectors. Doing so will damage the motherboard!



You can connect the front panel USB cable to the ASUS Q-Connector (USB, blue) first, and then install the Q-Connector (USB) to the USB connector onboard if your chassis supports front panel USB ports.

5. IEEE 1394a port connector (10-1 pin IE1394_1, IE1394_2)

This connector is for a IEEE 1394a port. Connect the IEEE 1394a module cable to this connector, then install the module to a slot opening at the back of the system chassis.

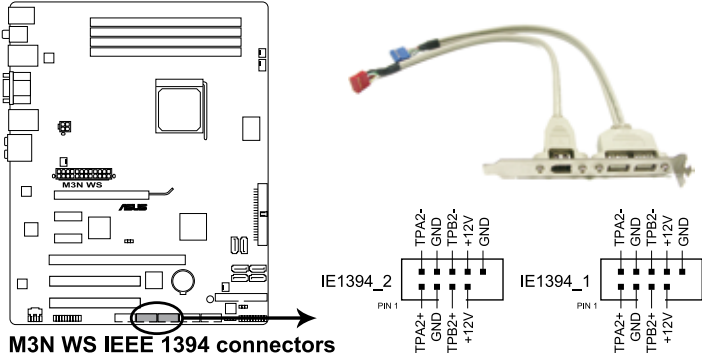

Never connect a USB cable to the IEEE 1394a connector. Doing so will damage the motherboard!



You can connect the front panel 1394 cable to the ASUS Q-Connector (1394, red) first, and then install the Q-Connector (1394) to the 1394 connector onboard if your chassis supports front panel 1394 ports.

6. CPU, chassis, and power fan connectors (4-pin CPU_FAN; 3-pin PWR_FAN; 3-pin CHA_FAN1-2; 3-pin PWR_FAN)

The fan connectors support cooling fans of 350 mA~2000 mA (24 W max.) or a total of 1 A~7 A (84 W max.) at +12V. Connect the fan cables to the fan connectors on the motherboard, making sure that the black wire of each cable matches the ground pin of the connector.



Do not forget to connect the fan cables to the fan connectors. Insufficient air flow inside the system may damage the motherboard components. These are not jumpers! Do not place jumper caps on the fan connectors!

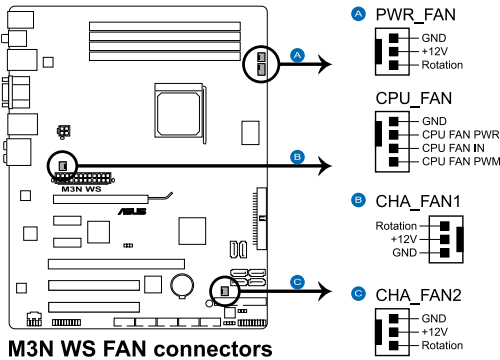

Only the CPU_FAN and CHA_FAN1-2 connectors support the ASUS Q FAN2 feature.

7. Chassis intrusion connector (4-1 pin CHASSIS)

This connector is for a chassis-mounted intrusion detection sensor or switch. Connect one end of the chassis intrusion sensor or switch cable to this connector. The chassis intrusion sensor or switch sends a high-level signal to this connector when a chassis component is removed or replaced. The signal is then generated as a chassis intrusion event.

By default , the pin labeled “Chassis Signal” and “Ground” are shorted with a jumper cap. Remove the jumper caps only when you intend to use the chassis intrusion detection feature.

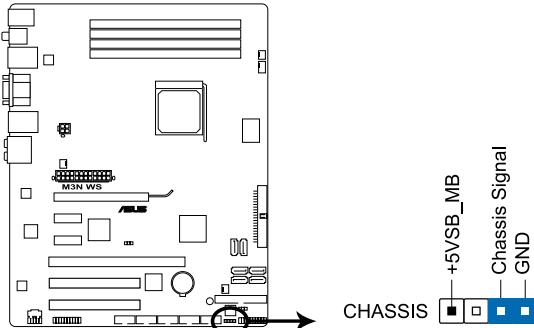

M3N WS Chassis intrusion connector

8. Optical drive audio connector (4-pin CD)

These connectors allow you to receive stereo audio input from sound sources such as a CD-ROM, TV tuner, or MPEG card.

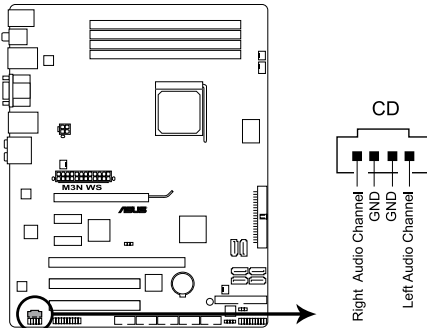

M3N WS Internal audio connector

9. ATX power connectors (24-pin EATXPWR; 4-pin ATX12V)

These connectors are for ATX power supply plugs. The power supply plugs are designed to fit these connectors in only one orientation. Find the proper orientation and push down firmly until the connectors completely fit.

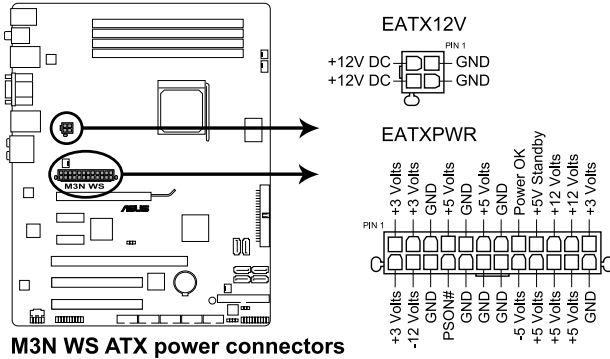

M3N WS ATX power connectors



- For a fully configured system, we recommend that you use a power supply unit (PSU) that complies with ATX 12 V Specification 2.0 (or later version) and provides a minimum power of 600 W.
- Do not forget to connect the 4-pin ATX +12 V power plug; otherwise, the system will not boot.
- Use of a PSU with a higher power output is recommended when configuring a system with more power-consuming devices. The system may become unstable or may not boot up if the power is inadequate.
- If you are uncertain about the minimum power supply requirement for your system, refer to the **Recommended Power Supply Wattage Calculator** at <http://support.asus.com/PowerSupplyCalculator/PSCalculator.aspx?SLanguage=en-us> for details.
- The ATX 12 V Specification 2.0-compliant (500W) PSU has been tested to support the motherboard power requirements with the following configuration:
CPU: AMD FX-62
Memory 1024 MB DDR2-800 (x4)
Graphics card: PCI Express x16 NVIDIA 7900GTX
Serial ATA device: SATA hard disk drive (x2)
Optical drives: DVD-RW

10. Front panel audio connector (10-1 pin AAFP)

This connector is for a chassis-mounted front panel audio I/O module that supports HD Audio standard. Connect one end of the front panel audio I/O module cable to this connector.

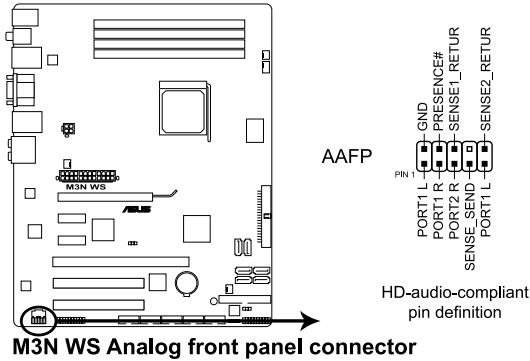

We recommend that you connect a high-definition front panel audio module to this connector to avail of the motherboard's high-definition audio capability.

11. TPM connector (20-1 pin TPM) [Optional]

This connector supports a Trusted Platform Module (TPM) system, which can securely store keys, digital certificates, passwords, and data. A TPM system also helps enhance network security, protects digital identities, and ensures platform integrity.

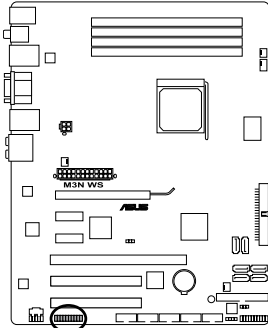

M3N WS TPM connector

12. System panel connector (20-8 pin PANEL)

This connector supports several chassis-mounted functions.

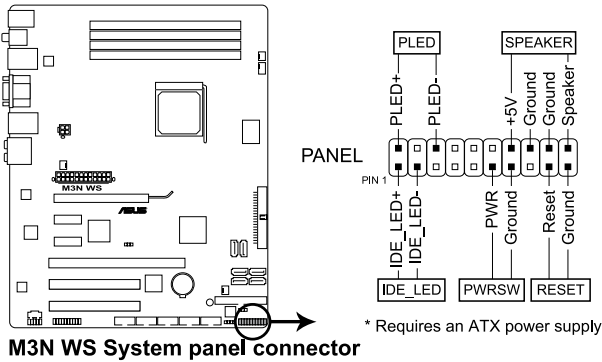

M3N WS System panel connector

- **System power LED (2-pin PLED)**

This 2-pin connector is for the system power LED. Connect the chassis power LED cable to this connector. The system power LED lights up when you turn on the system power, and blinks when the system is in sleep mode.

- **Hard disk drive activity LED (2-pin IDE_LED)**

This 2-pin connector is for the HDD Activity LED. Connect the HDD Activity LED cable to this connector. The IDE LED lights up or flashes when data is read from or written to the HDD.

- **System warning speaker (4-pin SPEAKER)**

This 4-pin connector is for the chassis-mounted system warning speaker. The speaker allows you to hear system beeps and warnings.

- **ATX power button/soft-off button (2-pin PWRSR)**

This connector is for the system power button. Pressing the power button turns the system on or puts the system in sleep or soft-off mode depending on the BIOS settings. Pressing the power switch for more than four seconds while the system is ON turns the system OFF.

- **Reset button (2-pin RESET)**

This 2-pin connector is for the chassis-mounted reset button for system reboot without turning off the system power.

13. ASUS Q-Connector (system panel)

You can use the ASUS Q-Connector to connect/disconnect chassis front panel cables in a few steps. Refer to the instructions below to install the ASUS Q-Connector.

1. Connect the front panel cables to the ASUS Q-Connector.
Refer to the labels on the Q-Connector to know the detailed pin definitions, then match them to the respective front panel cable labels.

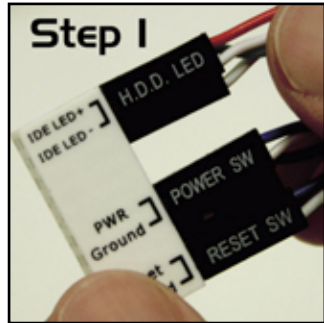

2. Install the ASUS Q-Connector to the system panel connector, making sure the orientation matches the labels on the motherboard.

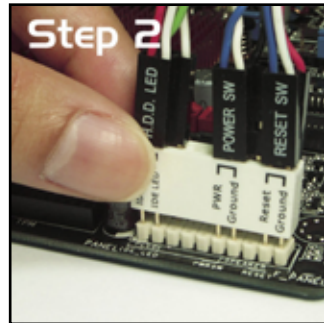

3. The front panel functions are now enabled. The figure shows the Q-Connector properly installed on the motherboard.

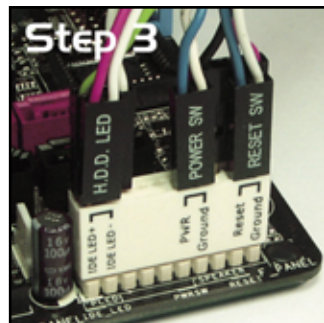

2.8 G.P. Diagnosis card installation

2.8.1 G.P. Diagnosis card layout

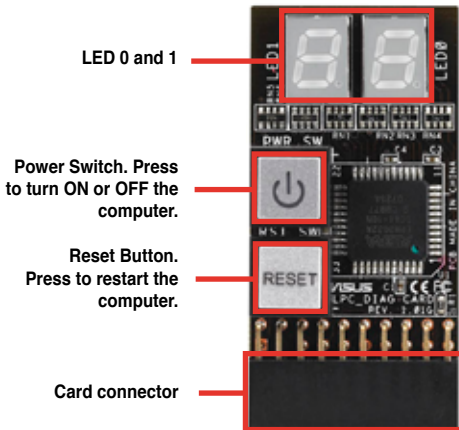

2.8.2 Installing G.P. Diagnosis card



Make sure to turn off the power supply unit before installing the diagnosis card to avoid electrical shock hazard.

1. Locate the **TPM connector (20-1 pin TPM)** on the motherboard.

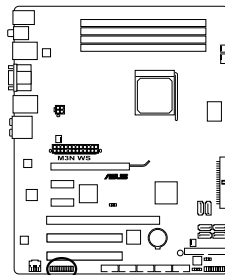

M3N WS TPM connector

2. With the LEDs of the diagnosis card facing to the DIMM sockets, align the card connector with the TPM connector and press firmly until the card sits on the connector completely.

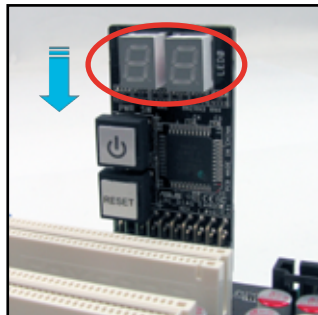

3. You may also install the G.P. Diagnosis card via a bundled 90-degree TPM adaptor for a more flexible application.

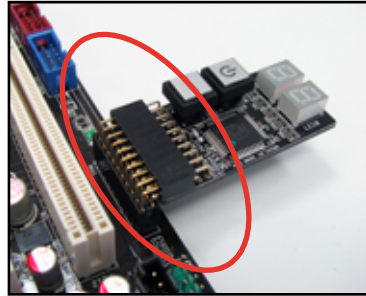

2.8.3 G.P. Diagnosis card check codes

C0	Early chipset initialization
C1	Detect memory
C3	Expand compressed BIOS code to DRAM
25	Early PCI initialization
26	<ol style="list-style-type: none"> 1. Set clock generator and disable unnecessary or unused clock 2. Init onboard PWM 3. Init onboard H/W monitor devices
2B	Invoke Video BIOS
2D	<ol style="list-style-type: none"> 1. Initialize double-byte language font (optional) 2. Put information on screen display, including Award title, CPU type, Cpu speed, full screen logo.
4E	<ol style="list-style-type: none"> 1. Program MTRR of CPU 2. Initialize L2 cache for CPU & program CPU with proper cacheable range. 3. Initialize APIC
50	Initialize USB Keyboard & Mouse.
52	Test all memory
75	Detect & install all IDE devices: HDD, LS120, ZIP, CD-ROM...
7F	<p>Switch back to text mode if full screen logo is supported.</p> <ul style="list-style-type: none"> - If errors occur, report errors & wait for keys. - If no errors occur or F1 key is pressed to continue: Clear EPA or customizatoin logo.
8B	<ol style="list-style-type: none"> 1. Invoke all ISA adapter ROMs 2. Invoke all PCI ROMs (except VGA)

(continued on the next page)

94	<ol style="list-style-type: none"> 1. Enable L2 cache 2. Program Daylight Saving 3. Program boot up speed 4. Chipset final initialization 5. Power management final initialization 6. Clear screen & display summary table.
96	<ol style="list-style-type: none"> 1. Build MP table. 2. Build & update ESCD. 3. Set CMOS century to 20h or 19h 4. Load CMOS time into DOS timer tick. 5. Build MSIRQ routing table.
0F	Reserved
F1	Sleep state S1
F3	Sleep state S3
F4	Sleep state S4
F5	Sleep state S5

2.9 Starting up for the first time

1. After making all the connections, replace the system case cover.
2. Be sure that all switches are off.
3. Connect the power cord to the power connector at the back of the system chassis.
4. Connect the power cord to a power outlet that is equipped with a surge protector.
5. Turn on the devices in the following order:
 - a. Monitor
 - b. External SCSI devices (starting with the last device on the chain)
 - c. System power
6. After applying power, the system power LED on the system front panel case lights up. For systems with ATX power supplies, the system LED lights up when you press the ATX power button. If your monitor complies with “green” standards or if it has a “power standby” feature, the monitor LED may light up or switch between orange and green after the system LED turns on.

The system then runs the power-on self tests or POST. While the tests are running, the BIOS beeps or additional messages appear on the screen. If you do not see anything within 30 seconds from the time you turned on the power, the system may have failed a power-on test. Check the jumper settings and connections or call your retailer for assistance.

BIOS beep codes

BIOS Beep	Description
One short beep	No keyboard detected
One continuous beep followed by two short beeps then a pause (repeated)	No memory detected
One continuous beep followed by three short beeps	No VGA detected
One continuous beep followed by four short beeps	Hardware component failure

7. At power on, hold down the <Delete> key to enter the BIOS Setup. Follow the instructions in Chapter 3.

2.10 Turning off the computer

2.10.1 Using the OS shut down function

If you are using Windows® XP:

1. Click the **Start** button then select **Turn Off Computer**.
2. Click the **Turn Off** button to shut down the computer.
3. The power supply should turn off after Windows® shuts down.

If you are using Windows® Vista™:

1. Click the **Start** button then select **ShutDown**.
2. The power supply should turn off after Windows® shuts down.

2.10.2 Using the dual function power switch

While the system is ON, pressing the power switch for less than four seconds puts the system to sleep mode or to soft-off mode, depending on the BIOS setting. Pressing the power switch for more than four seconds lets the system enter the soft-off mode regardless of the BIOS setting. Refer to section **3.5 Power Menu** in Chapter 3 for details.

This chapter tells how to change the system settings through the BIOS Setup menus. Detailed descriptions of the BIOS parameters are also provided.

BIOS setup **3**

3.1	Managing and updating your BIOS	3-1
3.2	BIOS setup program	3-11
3.3	Main menu	3-15
3.4	Advanced menu	3-20
3.5	Power menu.....	3-31
3.6	Boot menu	3-35
3.7	Tools menu	3-39
3.8	Exit menu	3-42

3.1 Managing and updating your BIOS

The following utilities allow you to manage and update the motherboard Basic Input/Output System (BIOS) setup.

1. **ASUS Update** (Updates the BIOS in Windows® environment.)
2. **ASUS EZ Flash 2** (Updates the BIOS using a floppy disk or USB flash disk.)
3. **AwardBIOS Flash Utility** (Updates the BIOS using a bootable floppy disk or a USB flash disk.)
4. **ASUS CrashFree BIOS 3** (Updates the BIOS using a bootable floppy disk, USB flash disk or the motherboard support DVD when the BIOS file fails or gets corrupted.)

Refer to the corresponding sections for details on these utilities.



Save a copy of the original motherboard BIOS file to a bootable USB flash disk in case you need to restore the BIOS in the future. Copy the original motherboard BIOS using the ASUS Update or Award BIOS Flash utilities.

3.1.1 ASUS Update utility

The ASUS Update is a utility that allows you to manage, save, and update the motherboard BIOS in Windows® environment. The ASUS Update utility allows you to:

- Save the current BIOS file
- Download the latest BIOS file from the Internet
- Update the BIOS from an updated BIOS file
- Update the BIOS directly from the Internet, and
- View the BIOS version information.

This utility is available in the support DVD that comes with the motherboard package.



ASUS Update requires an Internet connection either through a network or an Internet Service Provider (ISP).

Installing ASUS Update

To install ASUS Update:

1. Place the support DVD in the optical drive. The Drivers menu appears.
2. Click the **Utilities** tab, then click **Install ASUS Update**.
3. The ASUS Update utility is copied to your system.



Quit all Windows® applications before you update the BIOS using this utility.

Updating the BIOS through the Internet

To update the BIOS through the Internet:

1. Launch the ASUS Update utility from the Windows® desktop by clicking **Start > Programs > ASUS > ASUSUpdate > ASUSUpdate**. The ASUS Update main window appears.

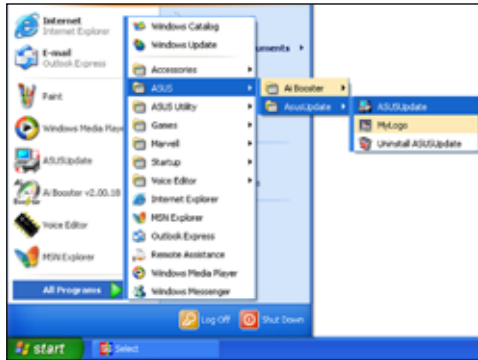

2. Select **Update BIOS** from the Internet option from the drop-down menu, then click **Next**.
3. Select the ASUS FTP site nearest you to avoid network traffic, or click **Auto Select**. Click **Next**.

- From the FTP site, select the BIOS version that you wish to download. Click **Next**.
- Follow the screen instructions to complete the update process.



The ASUS Update utility is capable of updating itself through the Internet. Always update the utility to avail all its features.



Updating the BIOS through a BIOS file

To update the BIOS through a BIOS file:

- Launch the ASUS Update utility from the Windows® desktop by clicking **Start > Programs > ASUS > ASUSUpdate > ASUSUpdate**. The ASUS Update main window appears.
- Select Update BIOS from a file option from the drop-down menu, then click **Next**.



- Locate the BIOS file from the Open window.
- Follow the screen instructions to complete the update process.

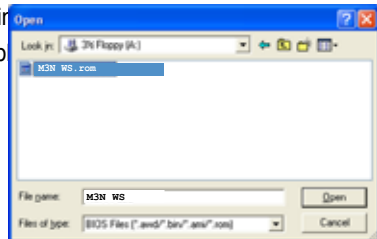

3.1.2 Creating a bootable floppy disk

1. Do either one of the following to create a bootable floppy disk.

DOS environment

- a. Insert a 1.44MB floppy disk into the drive.
- b. At the DOS prompt, type `format a: /s` then press <Enter>.

Windows® XP environment

- a. Insert a 1.44 MB floppy disk to the floppy disk drive.
- b. Click **Start** from the Windows® desktop, then select **My Computer**.
- c. Select the 3 1/2 Floppy Drive icon.
- d. Click File from the menu, then select **Format**. A **Format 3 1/2 Floppy Disk** window appears.
- e. Select **Create an MS-DOS startup disk** from the format options field, then click **Start**.

Windows® Vista environment

- a. Insert a formatted, high density 1.44 MB floppy disk to the floppy disk drive.
 - b. Click  from the Windows® desktop, then select **Computer**.
 - c. Right-click **Floppy Disk Drive** then click **Format** to display the **Format 3 1/2 Floppy** dialog box .
 - d. Select the **Create an MS-DOS startup disk** check box.
 - e. Click **Start**.
2. Copy the original or the latest motherboard BIOS file to the bootable floppy disk.

3.1.3 ASUS EZ Flash 2 utility

The ASUS EZ Flash 2 feature allows you to update the BIOS without having to go through the long process of booting from a floppy disk and using a DOS-based utility. The EZ Flash 2 utility is built-in the BIOS chip so it is accessible by pressing <Alt> + <F2> during the Power-On Self Tests (POST).

To update the BIOS using EZ Flash 2:

1. Visit the ASUS website (www.asus.com) to download the latest BIOS file for the motherboard.
2. Save the BIOS file to a floppy disk or a USB flash disk, then restart the system.
3. You can launch the EZ Flash 2 by two methods.
 - (1) Insert the floppy disk / USB flash disk that contains the BIOS file to the floppy disk drive or the USB port.

Press <Alt> + <F2> during POST to display the following.

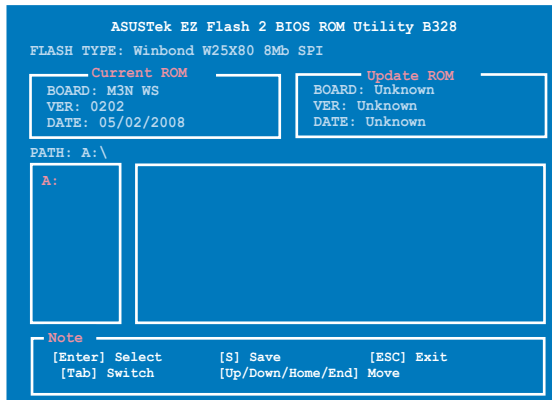

- (2) Enter BIOS setup program. Go to the **Tools** menu to select **EZ Flash 2** and press <Enter> to enable it.

You can switch between drives by pressing <Tab> before the correct file is found. Then press <Enter>.

4. When the correct BIOS file is found, EZ Flash 2 performs the BIOS update process and automatically reboots the system when done.



- This function can support devices such as USB flash disks, or floppy disks with **FAT 32/16** format and single partition only.
- Do not shut down or reset the system while updating the BIOS to prevent system boot failure!

3.1.4 Updating the BIOS

The Basic Input/Output System (BIOS) can be updated using the AwardBIOS Flash Utility. Follow these instructions to update the BIOS using this utility.

1. Visit the ASUS website (www.asus.com) and download the latest BIOS file for the motherboard. Save the BIOS file to a bootable floppy disk or a USB flash disk in **FAT 16/12 format**.



Save only the updated BIOS file in the disk to avoid loading the wrong BIOS file.

2. Copy the AwardBIOS Flash Utility (`awdflash.exe`) from the Software folder of the support DVD to the floppy disk or the USB flash disk with the latest BIOS file.
3. Boot the system in DOS mode using the floppy disk or the USB flash disk you created earlier.
4. Under the DOS mode, use `<X:>` (X stands for the name of the disk assignment) to switch to the folder of the floppy disk or the USB flash disk you saved the BIOS file and AwardBIOS Flash Utility.
5. At the prompt, type **awdflash** then press `<Enter>`. The AwardBIOS Flash Utility screen appears.

```
AwardBIOS Flash Utility for ASUS V1.33
(C) Phoenix Technologies Ltd. All Rights Reserved

For MCP78-M3N WS-00          DATE:01/08/2008
Flash Type -

File Name to Program: _____

Message: Please input File Name!
```

6. Type the BIOS file name in the File Name to Program field, then press <Enter>.

```
AwardBIOS Flash Utility for ASUS V1.33
(C) Phoenix Technologies Ltd. All Rights Reserved

For MCP78-M3N WS-00      DATE:01/08/2008
Flash Type -

File Name to Program: M3N WS.bin

Message: Do You Want To Save Bios (Y/N)
```

7. Press <N> when the utility prompts you to save the current BIOS file. The following screen appears.
8. The utility verifies the BIOS file in the floppy disk or the USB flash disk and starts flashing the BIOS file.

```
AwardBIOS Flash Utility for ASUS V1.33
(C) Phoenix Technologies Ltd. All Rights Reserved

For MCP78-M3N WS-00      DATE:01/08/2008
Flash Type -

File Name to Program: M3N WS.bin

Programming Flash Memory - OFE00 OK

Write OK   No Update   Write Fail

Warning: Don't Turn Off Power Or Reset System!
```



Do not turn off or reset the system during the flashing process!

9. The utility displays a Flashing Complete message indicating that you have successfully flashed the BIOS file. Remove the disk then press <F1> to restart the system.

```
AwardBIOS Flash Utility for ASUS V1.33
(C) Phoenix Technologies Ltd. All Rights Reserved

For MCP78-M3N WS-00      DATE:01/08/2008
Flash Type -

File Name to Program: M3N WS.bin
Flashing Complete
Press <F1> to Continue

Write OK   No Update   Write Fail

F1 Reset
```

3.1.5 Saving the current BIOS file

You can use the AwardBIOS Flash Utility to save the current BIOS file. You can load the current BIOS file when the BIOS file gets corrupted during the flashing process.



Make sure that the floppy disk or the USB flash disk has enough disk space to save the file.

To save the current BIOS file using the AwardBIOS Flash Utility:

1. Follow steps 1 to 6 of the previous section.
2. Press <Y> when the utility prompts you to save the current BIOS file. The following screen appears.

```
AwardBIOS Flash Utility for ASUS V1.33
(C) Phoenix Technologies Ltd. All Rights Reserved

For MCP78-M3N WS-00          DATE:01/08/2008
Flash Type -

File Name to Program: 0112.bin
Save current BIOS as:

Message:
```

3. Type a filename for the current BIOS file in the Save current BIOS as field, then press <Enter>.

```
AwardBIOS Flash Utility for ASUS V1.33
(C) Phoenix Technologies Ltd. All Rights Reserved

For MCP78-M3N WS-00          DATE:01/08/2008
Flash Type -

File Name to Program: 0112.bin
Checksum: 810DH
Save current BIOS as: 0113.bin

Message: Please Wait!
```

4. The utility saves the current BIOS file to the floppy disk or the USB flash disk, and then returns to the BIOS flashing process.

```
AwardBIOS Flash Utility for ASUS V1.33
(C) Phoenix Technologies Ltd. All Rights Reserved

For MCP78-M3N WS-00          DATE:01/08/2008
Flash Type -

File Name to Program: 0113.bin
Now Backup System BIOS to
File!

Message: Please Wait!
```

3.1.6 ASUS CrashFree BIOS 3 utility

The ASUS CrashFree BIOS 3 is an auto recovery tool that allows you to restore the BIOS file when it fails or gets corrupted during the updating process. You can update a corrupted BIOS file using the motherboard support DVD or the USB flash disk that contains the updated BIOS file.



- Prepare the motherboard support DVD or the USB flash disk containing the updated motherboard BIOS before using this utility.
- You can monitor the BIOS recovery process on your display only when installing an external graphics card.
- If you use the onboard VGA output, your display does not show when the BIOS recovery is proceeding. Insert the support DVD to the optical drive and wait for a few minutes to restart your system.

Recovering the BIOS from the support DVD

To recover the BIOS from the support DVD:

1. Turn on the system.
2. Insert the motherboard support DVD to the optical drive.
3. The utility displays the following message and automatically checks the DVD for the BIOS file.

```
Bad BIOS checksum. Starting BIOS recovery...  
Checking for floppy...
```

When found, the utility reads the BIOS file and starts flashing the corrupted BIOS file.

```
Bad BIOS checksum. Starting BIOS recovery...  
Checking for floppy...  
Floppy found!  
Reading file "M3N WS.ROM". Completed.  
Start flashing...
```

4. Restart the system after the utility completes the updating process.

Recovering the BIOS from the USB flash disk

To recover the BIOS from the USB flash disk:

1. Insert the USB flash disk that contains the BIOS file to the USB port.
2. Turn on the system.
3. The utility will automatically checks the devices for the BIOS file. When found, the utility reads the BIOS file and starts flashing the corrupted BIOS file.
4. Restart the system after the utility completes the updating process.



-
- Only the USB flash disk with FAT 32/16/12 format and single partition can support ASUS CrashFree BIOS 3. The device size should be smaller than 8GB.
 - DO NOT shut down or reset the system while updating the BIOS! Doing so can cause system boot failure!
-

3.2 BIOS setup program

This motherboard supports a programmable firmware chip that you can update using the provided utility described in section **3.1 Managing and updating your BIOS**.

Use the BIOS Setup program when you are installing a motherboard, reconfiguring your system, or prompted to “Run Setup.” This section explains how to configure your system using this utility.

Even if you are not prompted to use the Setup program, you can change the configuration of your computer in the future. For example, you can enable the security password feature or change the power management settings. This requires you to reconfigure your system using the BIOS Setup program so that the computer can recognize these changes and record them in the CMOS RAM.

The firmware chip on the motherboard stores the Setup utility. When you start up the computer, the system provides you with the opportunity to run this program. Press during the Power-On Self-Test (POST) to enter the Setup utility; otherwise, POST continues with its test routines.

If you wish to enter Setup after POST, restart the system by pressing <Ctrl+Alt+Delete>, or by pressing the reset button on the system chassis. You can also restart by turning the system off and then back on. Do this last option only if the first two failed.

The Setup program is designed to make it as easy to use as possible. Being a menu-driven program, it lets you scroll through the various sub-menus and make your selections from the available options using the navigation keys.



-
- The default BIOS settings for this motherboard apply for most conditions to ensure optimum performance. If the system becomes unstable after changing any BIOS settings, load the default settings to ensure system compatibility and stability. Select the **Load Default Settings** item under the Exit Menu. See section **3.8 Exit Menu**.
 - The BIOS setup screens shown in this section are for reference purposes only, and may not exactly match what you see on your screen.
 - Visit the ASUS website (www.asus.com) to download the latest BIOS file for this motherboard.
-

3.2.1 BIOS menu screen

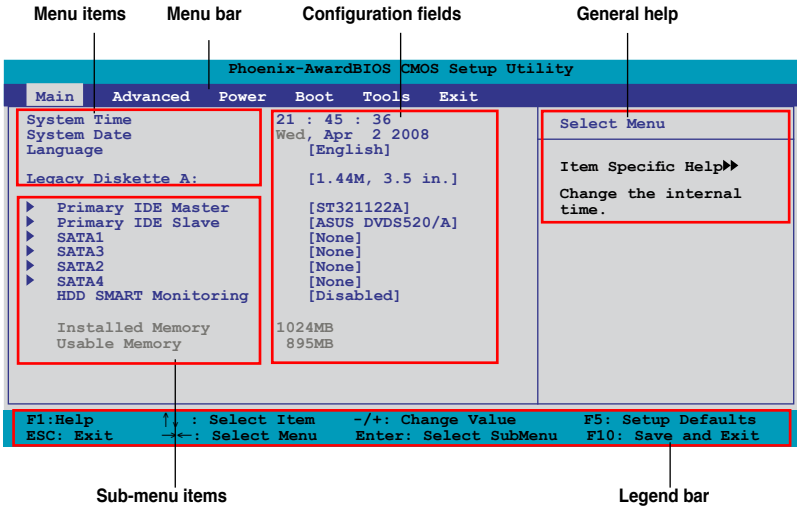

3.2.2 Menu bar

The menu bar on top of the screen has the following main items:

- Main** For changing the basic system configuration
- Advanced** For changing the advanced system settings
- Power** For changing the advanced power management (APM) configuration
- Boot** For changing the system boot configuration
- Tools** For configuring options for special functions
- Exit** For selecting the exit options and loading default settings

To select an item on the menu bar, press the right or left arrow key on the keyboard until the desired item is highlighted.



- The BIOS setup screens shown in this chapter are for reference purposes only, and may not exactly match what you see on your screen.
- Visit the ASUS website (www.asus.com) to download the latest BIOS information.

3.2.3 Legend bar

At the bottom of the Setup screen is a legend bar. The keys in the legend bar allow you to navigate through the various setup menus. The following table lists the keys found in the legend bar with their corresponding functions.

Navigation Key	Function
<F1>	Displays the General Help screen
<F5>	Loads setup default values
<Esc>	Exits the BIOS setup or returns to the main menu from a sub-menu
Left or Right arrow	Selects the menu item to the left or right
Up or Down arrow	Moves the highlight up or down between fields
Page Down or – (minus)	Scrolls backward through the values for the highlighted field
Page Up or + (plus)	Scrolls forward through the values for the highlighted field
<Enter>	Brings up a selection menu for the highlighted field
<F10>	Saves changes and exit

3.2.4 Menu items

The highlighted item on the menu bar displays the specific items for that menu. For example, selecting **Main** shows the Main menu items.

The other items (Advanced, Power, Boot, and Exit) on the menu bar have their respective menu items.

3.2.5 Sub-menu items

A solid triangle before each item on any menu screen means that the item has a sub-menu. To display the sub-menu, select the item and press <Enter>.

3.2.6 Configuration fields

These fields show the values for the menu items. If an item is user-configurable, you can change the value of the field opposite the item. You cannot select an item that is not user-configurable.

A configurable field is enclosed in brackets, and is highlighted when selected. To change the value of a field, select it then press <Enter> to display a list of options. Refer to **3.2.7 Pop-up window**.

3.2.7 Pop-up window

Select a menu item then press <Enter> to display a pop-up window with the configuration options for that item.

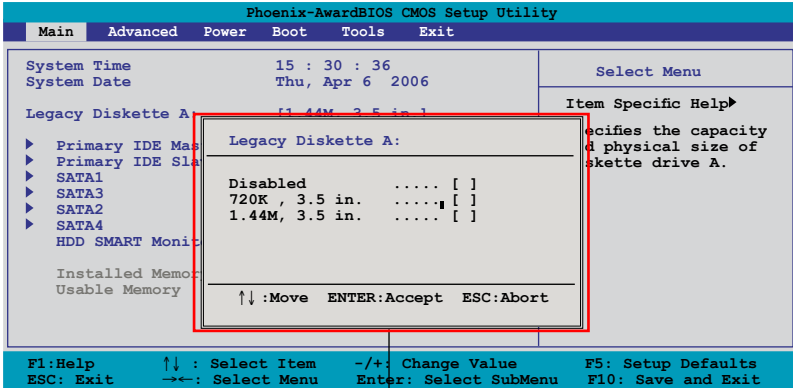

Pop-up menu

3.2.8 General help

At the top right corner of the menu screen is a brief description of the selected item.

3.3 Main menu

When you enter the BIOS Setup program, the Main menu screen appears, giving you an overview of the basic system information.



Refer to section **3.2.1 BIOS menu screen** for information on the menu screen items and how to navigate through them.

Phoenix-AwardBIOS CMOS Setup Utility		
Main	Advanced	Power Boot Tools Exit
System Time	19 : 49 : 36	Select Menu
System Date	Thu, Apr 3 2008	Item Specific Help▶
Language	[English]	Change the internal time.
Legacy Diskette A:	[1.44M, 3.5 in.]	
▶ Primary IDE Master	[None]	
▶ Primary IDE Slave	[None]	
▶ SATA1	[HDT722516DLA380]	
▶ SATA3	[ASUS CRW-5232]	
▶ SATA2	[None]	
▶ SATA4	[None]	
HDD SMART Monitoring	[Disabled]	
Installed Memory	1024MB	
Usable Memory	895MB	
F1:Help	↑↓ : Select Item	-/+ : Change Value
ESC: Exit	→← : Select Menu	Enter: Select SubMenu
		F5: Setup Defaults
		F10: Save and Exit

3.3.1 System Time [xx:xx:xx]

Allows you to set the system time.

3.3.2 System Date [Day xx/xx/xxxx]

Allows you to set the system date.

3.3.3 Language [English]

Allows you to select the display language for the BIOS setup screen.

Configuration options: [English] [French] [Deutsch] [Chinese(Trad.)]

[Chinese(Simp.)] [Japanese]

3.3.4 Legacy Diskette A [1.44M, 3.5 in.]

Sets the type of floppy drive installed.

Configuration options: [Disabled] [720K , 3.5 in.] [1.44M, 3.5 in.]

3.3.5 Primary IDE Master/Slave

While entering Setup, the BIOS automatically detects the presence of IDE devices. There is a separate sub-menu for each IDE device. Select a device item then press <Enter> to display the IDE device information.

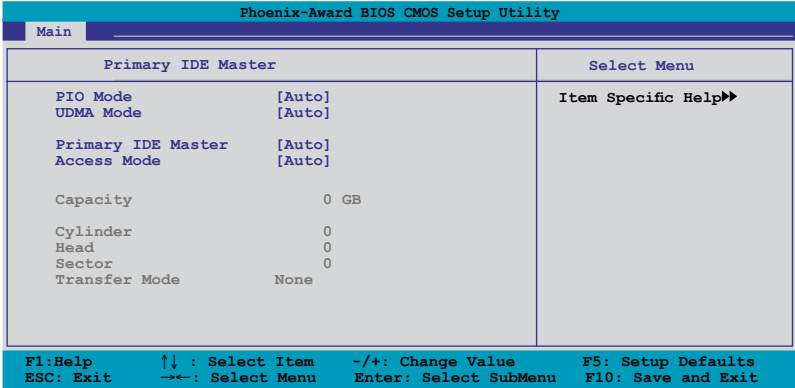

The BIOS automatically detects the values opposite the dimmed items (Capacity, Cylinder, Head, Sector and Transfer Mode). These values are not user-configurable. These items show N/A if no IDE device is installed in the system.

PIO Mode [Auto]

Sets the PIO mode for the IDE device.

Configuration options: [Auto] [Mode 0] [Mode 1] [Mode 2] [Mode 3] [Mode 4]

UDMA Mode [Auto]

Disables or sets the UDMA mode.

Configuration options: [Disable] [Auto]

Primary IDE Master/Slave [Auto]

Select [Auto] to automatically detect an IDE hard disk drive. If automatic detection is successful, the BIOS automatically fills in the correct values for the remaining fields on this sub-menu. If the hard disk was already formatted on a previous system, the setup BIOS may detect incorrect parameters. Select [Manual] to manually enter the IDE hard disk drive parameters. If no drive is installed select [None].

Configuration options: [None] [Auto] [Manual]

Access Mode [Auto]

The default [Auto] allows automatic detection of an IDE hard disk drive. Select [CHS] for this item if you set the IDE Primary Master/Slave to [Manual]. Configuration options: [CHS] [LBA] [Large] [Auto]



Before attempting to configure a hard disk drive, make sure you have the correct configuration information supplied by the drive manufacturer. Incorrect settings may cause the system to fail to recognize the installed hard disk.

Capacity

Displays the auto-detected hard disk capacity. This item is not configurable.

Cylinder

Shows the number of the hard disk cylinders. This item is not configurable.

Head

Shows the number of the hard disk read/write heads. This item is not configurable.

Sector

Shows the number of sectors per track. This item is not configurable.

Transfer Mode

Shows the Transfer mode. This item is not configurable.



After entering the IDE hard disk drive information into BIOS, use a disk utility, such as FDISK, to partition and format new IDE hard disk drives. This is necessary so that you can write or read data from the hard disk. Make sure to set the partition of the Primary IDE hard disk drives to active.

3.3.6 SATA1/2/3/4

While entering Setup, the BIOS automatically detects the presence of Serial ATA devices. There is a separate sub-menu for each SATA device. Select a device item then press <Enter> to display the SATA device information.

Phoenix-Award BIOS CMOS Setup Utility		
Main		
SATA1		Select Menu
Extended IDE Drive Access Mode	[Auto] [Auto]	Item Specific Help▶▶ Selects the type of fixed disk connected to the system.
Capacity	164 GB	
Cylinder	65535	
Head	16	
Landing Zone	65534	
Sector	255	
F1: Help ↑↓ : Select Item -/+ : Change Value F5: Setup Defaults ESC: Exit →← : Select Menu Enter: Select SubMenu F10: Save and Exit		

The BIOS automatically detects the values opposite the dimmed items (Capacity, Cylinder, Head, Landing Zone and Sector). These values are not user-configurable. These items show 0 if no SATA device is installed in the system.

Extended IDE Drive [Auto]

Selects the type of fixed disk connected to the system.

Configuration options: [None] [Auto]

Access Mode [Auto]

Sets the sector addressing mode.

Configuration options: [Large] [Auto]



Before attempting to configure a hard disk drive, make sure you have the correct configuration information supplied by the drive manufacturer. Incorrect settings may cause the system to fail to recognize the installed hard disk.

Capacity

Displays the auto-detected hard disk capacity. This item is not configurable.

Cylinder

Shows the number of the hard disk cylinders. This item is not configurable.

Head

Shows the number of the hard disk read/write heads. This item is not configurable.

Landing Zone

Shows the number of landing zone per track. This item is not configurable.

Sector

Shows the number of sectors per track. This item is not configurable.



After entering the IDE hard disk drive information into BIOS, use a disk utility, such as FDISK, to partition and format new IDE hard disk drives. This is necessary so that you can write or read data from the hard disk. Make sure to set the partition of the Primary IDE hard disk drives to active.

3.3.7 HDD SMART Monitoring [Disabled]

Allows you to enable or disable the HDD Self-Monitoring Analysis and Reporting Technology (SMART) feature.

Configuration options: [Disabled] [Enabled]

3.3.8 Installed Memory [xxx MB]

Shows the size of installed memory. This item is not configurable.

3.3.9 Usable Memory [XXX MB]

Shows the size of usable memory. This item is not configurable.

3.4 Advanced menu

The Advanced menu items allow you to change the settings for the CPU and other system devices.



Take caution when changing the settings of the Advanced menu items. Incorrect field values can cause the system to malfunction.



The configuration options for the Advanced menu items vary depending on the CPU and DIMMs you install on the motherboard.

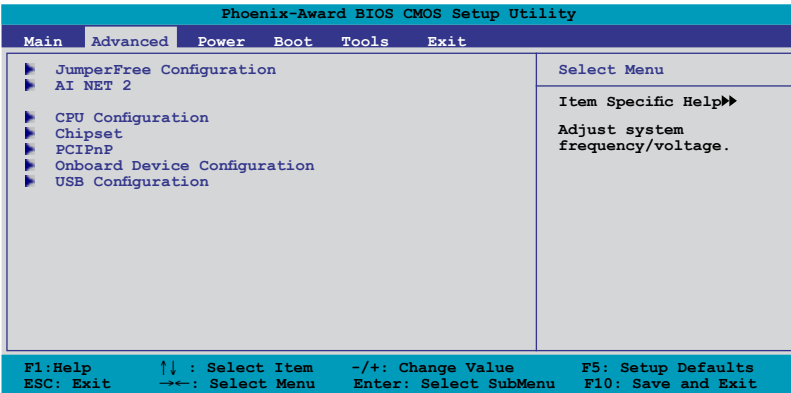

3.4.1 JumperFree Configuration

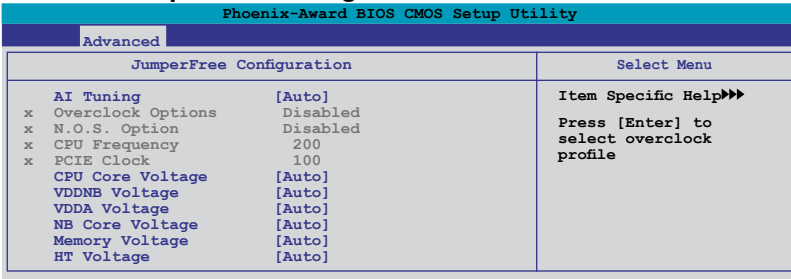

AI Tuning [Auto]

Allows selection of CPU overclocking options to achieve desired CPU internal frequency. Select either one of the preset overclocking configuration options:

Manual	Allows you to individually set overclocking parameters.
Auto	Loads the optimal settings for the system.
Standard	Loads the standard settings for the system.
AI Overclock	Loads overclocking profiles with optimal parameters for stability when overclocking.
AI N.O.S.	The ASUS Non-delay Overclocking System feature intelligently determines the system load and automatically boosts the performance for the most demanding tasks.

Overclock Options [Disabled]

This item becomes user-configurable only when you set the **AI Tuning** item to [AI Overclock] and allows you to set the overclocking options.

Configuration options: [Disabled] [Overclock 3%] [Overclock 5%] [Overclock 8%] [Overclock 10%]

N.O.S. Option [Disabled]

This item becomes user-configurable only when you set the **AI Tuning** item to [AI N.O.S.] and allows you to set the overclocking options.

Configuration options: [Disabled] [Overclock 3%] [Overclock 5%] [Overclock 8%] [Overclock 10%]

CPU Frequency [200]

This item becomes user-configurable only when you set the **AI Tuning** item to [Manual] and allows configuration of the CPU frequency. This item is adjusted by typing the desired values using the numeric keypad and press the <Enter> key. The values range from 200 to 600.

PCIe Clock [100]

This item becomes user-configurable only when you set the **AI Tuning** item to [Manual] and is adjusted by typing the desired values using the numeric keypad and press the <Enter> key. The values range from 100 to 200.

CPU Core Voltage [Auto]

Allows you to set the CPU Core voltage.

Configuration options: [Auto] [+ 12.5mv] [+100.0mv] [+112.5mv] [+200.0mv] [+212.5mv] [+300.0mv] [+312.5mv]

VDDNB Voltage [Auto]

Allows you to set the VDDNB Voltage.

Configuration options: [Auto] [+ 12.5mv] [+100.0mv] [+112.5mv] [+200.0mv] [+212.5mv] [+300.0mv] [+312.5mv]

VDDA Voltage [Auto]

Allows you to set the VDDA Voltage.

Configuration option: [Auto] [2.622V] [2.728V] [2.830V]

NB Core Voltage [Auto]

Allows you to set the NB Core Voltage.

Configuration options: [Auto] [1.10V] [1.12V] [1.14V] ~ [1.34V] [1.36V] [1.38V]

Memory Voltage [Auto]

Allows you to set the memory voltage.

Configuration options: [Auto] [1.800V] [1.820V] [1.840V] ~ [2.460V] [2.480V] [2.500V]

HT Voltage [Auto]

Allows you to set the 1.2V HyperTransport voltage.

Configuration options: [Auto] [1.20V] [1.22V] [1.24V] ~ [1.46V] [1.48V] [1.50V]

3.4.2 Ai Net 2

This menu displays the status of the Local Area Network (LAN) cable connected to the LAN (RJ-45) port.

Phoenix-Award BIOS CMOS Setup Utility			
Advanced			Select Menu
AI NET 2			
POST Check LAN Cable		[Disabled]	Item Specific Help▶▶▶
Pair	Status	Length	Enable or Disable LAN cable check during POST.
LAN1 (1-2)	Open	N/A	
LAN1 (3-6)	Open	N/A	
LAN1 (4-5)	Open	N/A	
LAN1 (7-8)	Open	N/A	
LAN2 (1-2)	Open	N/A	
LAN2 (3-6)	Open	N/A	
LAN2 (4-5)	Open	N/A	
LAN2 (7-8)	Open	N/A	

POST Check LAN cable [Disabled]

Allows you to enable or disable LAN cable check during POST. When enabled, the menu reports the cable faults or shorts, and displays the point (length) where the faults or shorts are detected.

Configuration options: [Disabled] [Enabled]

3.4.3 CPU Configuration

Phoenix-Award BIOS CMOS Setup Utility			
Advanced			Select Menu
CPU Configuration			
CPU Type	AMD Phenom(tm)9600 Quad-Core Processor		Item Specific Help▶▶▶
CPU Speed	2300MHz		DRAM timing and control
Cache RAM (L2)	512K x4		
Cache RAM (L3)	2048K		
▶ DRAM Configuration			
AMD Virtualization	[Enabled]		
AMD Live!	[Disabled]		
AMD Cool'n'Quiet Function	[Disabled]		

DRAM Configuration

This sub-menu allows you to adjust the DRAM-related items. Select an item, then press <Enter> to edit.

Phoenix-Award BIOS CMOS Setup Utility		
Advanced		Select Menu
DRAM Configuration		Select Menu
Memory clock Frequency	[Auto]	Item Specific Help▶▶▶
Tcl	[Auto]	Auto, no user limit
Trcd	[Auto]	MaxMemClk, limit by
Trp	[Auto]	Memory clock value
Tras	[Auto]	Manual, use Memory
Trc	[Auto]	Clock value
1T/2T Memory Timing	[Auto]	
Memory Hole Remapping	[Enabled]	
▶ Advance Memory Settings		

Memory Clock Frequency [Auto]

This item allows you to adjust the memory clock frequency.

Configuration options: [Auto] [DDR2 533] [DDR2 667] [DDR2 800] [DDR2 1066]

Tcl [Auto]

Configuration options: [Auto] [3] [4] [5] [6] [7]

Trcd [Auto]

Configuration options: [Auto] [3] [4] [5] [6]

Trp [Auto]

Configuration options: [Auto] [3] [4] [5] [6]

Tras [Auto]

Configuration options: [Auto] [5] [6] [7] ~ [16] [17] [18]

Trc [Auto]

Configuration options: [Auto] [11] [12] [13] ~ [24] [25] [26]

1T/2T Memory Timing [Auto]

Configuration options: [Auto] [1T] [2T]

Memory Hole Remapping [Enabled]

Allows you to enable or disable memory hole remapping support.

Configuration options: [Disabled] [Enabled]

Advance Memory Settings

This sub-menu allows you to adjust the Advance Memory Settings. Select an item, then press <Enter> to edit.

Phoenix-Award BIOS CMOS Setup Utility		
Advanced		
Advance Memory Settings		Select Menu
Twr	[Auto]	Item Specific Help▶▶▶
Trrd	[Auto]	Auto, no user limit
Trwt	[Auto]	MaxMemClk, limit by
Twtr	[Auto]	Memory clock value
Trtp	[Auto]	Manual, use Memory
Twrrd	[Auto]	Clock value
Twrwr	[Auto]	
Trdrd	[Auto]	
Tref	[Auto]	
Trfc	[Auto]	
Max Async Latency	[Auto]	
R/W Queue Bypass	[Auto]	
Dynamic Idle Cycle Counter	[Auto]	
DCQ Bypass Maximum	[Auto]	
RdPadPcvFIFO Delay	[Auto]	
Disable Jitter	[Auto]	
DRAM Bank Interleaving	[Enabled]	
Bank Swizzle Mode	[Enabled]	

Twr [Auto]

Configuration options: [Auto] [3] [4] [5] [6]

Trrd [Auto]

Configuration options: [Auto] [2] [3] [4] [5]

Trwt [Auto]

Configuration options: [Auto] [2] [3] ~ [8] [9]

Twtr [Auto]

Configuration options: [Auto] [1] [2] [3]

Trtp [Auto]

Configuration options: [Auto] [2/4] [3/5]

Twrrd [Auto]

Configuration options: [Auto] [0] [1] [2] [3]

Twrwr [Auto]

Configuration options: [Auto] [1] [2] [3]

Trdrd [Auto]

Configuration options: [Auto] [2] [3] [4] [5]

Tref [Auto]

Configuration options: [Auto] [7.8 us] [3.9 us]

Trfc [Auto]

Configuration options: [Auto] [0] [1] [2] [3] [4]

Max Async Latency [Auto]

Configuration options: [Auto] [0 ns] [1 ns] [2 ns] ~ [13 ns] [14 ns] [15 ns]

R/W Queue Bypass [Auto]

Configuration options: [Auto] [2x] [4x] [8x] [16x]

Dynamic Idle Cycle Counter [Auto]

Configuration options: [Auto] [Disabled] [Enabled]

DCQ Bypass Maximum[Auto]

Configuration options: [Auto] [0x] [1x] [2x] ~ [13x] [14x] [15x]

RdPadRcvFIFO Delay [Auto]

Configuration options: [Auto] [1.5] [2] [2.5] [3] [3.5]

Disable Jitter [Auto]

Configuration options: [Auto] [OFF] [ON]

DRAM Bank Interleaving [Enabled]

Configuration options: [Disabled] [Enabled]

Bank Swizzle Mode [Enabled]

Configuration options: [Disabled] [Enabled]

AMD Virtualization [Enabled]

The Vanderpool Technology allows a hardware platform to run multiple operating systems separately and simultaneously, enabling one system to virtually function as several systems.

Configuration options: [Enabled] [Disabled]

AMD Live! [Disabled]

Enables or disables the AMD® Live! Technology.

Configuration options: [Disabled] [Enabled]

AMD Cool'n'Quiet Function [Disabled]

Enables or disables the AMD Cool'n'Quiet function.

Configuration options: [Disabled] [Enabled]

3.4.4 Chipset

Phoenix-Award BIOS CMOS Setup Utility		
Advanced		
Chipset		Select Menu
Hybrid Support	[Auto]	Item Specific Help▶▶▶
iGPU Frame Buffer Control	[Auto]	
x Frame Buffer Size	128M	
Onboard GPU	[Auto]	
RS<->NB HT Speed	[Auto]	
RS<->NB HT Width	[Auto]	
CPU Spread Spectrum	[Disabled]	
PCIe Spread Spectrum	[Disabled]	
SATA Spread Spectrum	[Disabled]	
Primary Display Adapter	[PCI-E]	

Hybrid Support [Auto]

Allows you to enable or disable the Hybrid SLI function if you install a Hybrid SLI-support graphics card.

Configuration options: [Auto] [Disabled].

iGPU Frame Buffer Control [Auto]

Allows you to set the onboard GPU frame buffer control mode.

Configuration options: [Auto] [Manual]

Frame Buffer Size [128M]

This item becomes user-configurable when you set the **iGPU Frame Buffer Control** item to [Manual] and allows you to set frame buffer size for onboard GPU.

Configuration options: [64M] [128M] [256M] [512M]



The configuration options for this item vary depending on the total memory size you install on the motherboard.

Onboard GPU [Auto]

Allows you to enable or disable the onboard GPU. Set this item to [Auto] to disable the onboard GPU if the system detects any external graphics card. Set this item to [Always Enable] to enable the onboard GPU even if the system detects any external graphics card.

Configuration options: [Auto] [Always Enable]

K8<->NB HT Speed [Auto]

Allows you to set the HyperTransport speed between the CPU and the Northbridge.

Configuration options: [Auto] [200 MHz] [400 MHz] [600 MHz] [800 MHz] [1 GHz] [1.2 GHz] [1.4 GHz] [1.6 GHz] [1.8 GHz] [2 GHz] [2.2 GHz] [2.4 GHz] [2.6 GHz]

K8<->NB HT Width [Auto]

Allows you to set the HyperTransport width between the CPU and the Northbridge..

Configuration options: [↓ 8 ↑ 8] [↓ 16 ↑ 16] [Auto]

CPU Spread Spectrum [Disabled]

Set to [Disabled] to enhance FSB overclocking ability or [Enabled] for EMI control.

Configuration options: [Disabled] [Enabled]

PCIE Spread Spectrum [Disabled]

Set to [Disabled] to enhance PCIE overclocking ability or [Down Spread] for EMI control.

Configuration options: [Disabled] [Down Spread]

SATA Spread Spectrum [Disabled]

Allows you to adjust the SATA spread spectrum setting.

Configuration options: [Disabled] [Down Spread]

Primary Display Adapter [PCI-E]

Allows you to select which graphics controller to use as the primary boot device.

Configuration options: [PCI] [PCI-E]

3.4.5 PCIPnP

Phoenix-Award BIOS CMOS Setup Utility		
Advanced		
PCIPnP		Select Menu
Plug & Play O/S	[No]	Item Specific Help▶▶▶
Resources Controlled By	[Auto]	Select Yes if you are using a Plug and Play capable operating system. Select No if you need the BIOS to configure non-boot devices.
x IRQ Resources		
PCI Express relative items		
Maximum Payload Size	[4096]	

Plug & Play O/S [No]

When set to [No], the BIOS configures all the devices in the system. When set to [Yes] and if you install a Plug and Play operating system, the operating system configures the Plug and Play devices not required for boot.

Configuration options: [No] [Yes]

Resources Controlled By [Auto]

When set to [Auto], the BIOS automatically configures all the boot and Plug and Play compatible devices. Set to [Manual] if you want to assign the IRQ DMA and memory base address fields.

Configuration options: [Auto] [Manual]



When the item Resources Controlled By is set to [Auto], the item **IRQ Resources** is grayed out and not user-configurable. Refer to the section **IRQ Resources** for information on how to enable this item.

IRQ Resources

This sub-menu is activated only when the **Resources Controlled By** item is set to [Manual].

Phoenix-Award BIOS CMOS Setup Utility		
Advanced		
IRQ Resources		Select Menu
IRQ-5 assigned to	[PCI Device]	Item Specific Help ▶▶▶
IRQ-7 assigned to	[PCI Device]	Legacy ISA for devices compliant with the original PC AT bus specification, PCI/ISA PnP for devices compliant with the Plug and Play standard
IRQ-9 assigned to	[PCI Device]	
IRQ-10 assigned to	[PCI Device]	
IRQ-11 assigned to	[PCI Device]	
IRQ-14 assigned to	[PCI Device]	

IRQ-xx assigned to [PCI Device]

When set to [PCI Device], the specific IRQ is free for use of PCI/PnP devices. When set to [Reserved], the IRQ is reserved for legacy ISA devices.

Configuration options: [PCI Device] [Reserved]

Maximum Payload Size [4096]

Sets maximum TLP payload size for the PCI Express devices. The unit is byte.

Configuration options: [128] [256] [512] [1024] [2048] [4096]

3.4.6 Onboard Device Configuration

Phoenix-Award BIOS CMOS Setup Utility	
Advanced	
Onboard Device Configuration	Select Menu
<ul style="list-style-type: none"> ▶ IDE Function Setup ▶ MCP Storage Config Onboard 1394 [Enabled] HD Audio [Enabled] HDMI Audio [Auto] Onboard LAN [Enabled] Onboard LAN Boot ROM [Disabled] Onboard 2nd LAN [Enabled] Onboard LAN2 Boot ROM [Disabled] 	Item Specific Help▶▶▶

IDE Function Setup

Phoenix-Award BIOS CMOS Setup Utility	
Advanced	
IDE Function Setup	Select Menu
<ul style="list-style-type: none"> OnChip IDE Channel0 [Enabled] IDE DMA transfer access [Enabled] SATA Controller [Enabled] IDE Prefetch Mode [Enabled] 	Item Specific Help ▶▶

OnChip IDE Channel 0 [Enabled]

Allows you to enable or disable the onchip IDE channel 0 controller .
 Configuration options: [Disabled] [Enabled]

IDE DMA transfer access [Enabled]

Allows you to enable or disable the IDE DMA transfer access.
 Configuration options: [Disabled] [Enabled]

SATA Controller [Enabled]

Allows you to enable or disable the onboard SATA controller.
 Configuration options: [Disabled] [Enabled]

IDE Prefetch Mode [Disabled]

Allows you to enable or disable the IDE PIO read prefetch mode.
 Configuration options: [Disabled] [Enabled]

MCP Storage Config

Phoenix-Award BIOS CMOS Setup Utility	
Advanced	
MCP Storage Config	Select Menu
SATA Operation Mode [IDE]	Item Specific Help ▶▶

SATA Operation Mode [IDE]

Allows you to select the onboard Serial ATA type.

Configuration options: [IDE] [RAID] [AHCI]



- If you want to use the Serial ATA hard disk drives as Parallel ATA physical storage devices, keep the default setting [IDE].
 - If you want the Serial ATA hard disk drives to use the Advanced Host Controller Interface (AHCI), set this item to [AHCI]. The AHCI allows the onboard storage driver to enable advanced Serial ATA features that increases storage performance on random workloads by allowing the drive to internally optimize the order of commands.
 - If you want to create a RAID 0, 1, 0+1, 5, or JBOD configuration from the Serial ATA hard disk drives, set this item to [RAID].
 - SATA 5-6 connectors support AHCI mode and RAID mode only. Make sure to install the AHCI driver or RAID driver in the bundled support DVD before connecting devices to SATA 5-6 connectors. Otherwise, the devices will not work.
 - Due to chipset limitation, when set any of SATA ports to RAID mode, all SATA ports run at RAID mode together.
-

Onboard 1394 [Enabled]

Allows you to enable or disable the onboard 1394 device support.

Configuration options: [Disabled] [Enabled]

HD Audio [Enabled]

Allows you to enable or disable the High-Definition audio CODEC.

Configuration options: [Enabled] [Disabled]

HDMI Audio [Auto]

Allows you to disable or enable the HDMI Audio function.

Configuration options: [Auto] [Disabled]



Make sure to set the **HDMI Audio** item to [Auto] to enable HDMI audio output.

Onboard LAN / Onboard 2nd LAN [Enabled]

Allows you to enable or disable the onboard LAN devices.

Configuration options: [Disabled] [Enabled]

Onboard LAN / LAN2 Boot ROM [Disabled]

Allows you to enable or disable the onboard LAN boot ROM.

Configuration options: [Enabled] [Disabled]

3.4.7 USB Configuration

Phoenix-Award BIOS CMOS Setup Utility	
Advanced	
USB Configuration	Select Menu
USB Controller [Enabled]	Item Specific Help ►►
USB 2.0 Controller [Enabled]	
USB Legacy support [Enabled]	

USB Controller [Enabled]

Allows you to enable or disable the USB 1.1 and 2.0 controller.

Configuration options: [Disabled] [Enabled]

USB 2.0 Controller [Enabled]

Allows you to enable or disable the USB 2.0 controller.

Configuration options: [Disabled] [Enabled]

USB Legacy support [Enabled]

Allows you to enable or disable support for USB devices on legacy operating systems (OS).

Configuration options: [Disabled] [Enabled]

3.5 Power menu

The Power menu items allow you to change the settings for the Advanced Configuration and Power Interface (ACPI) and the Advanced Power Management (APM). Select an item then press <Enter> to display the configuration options.

Phoenix-Award BIOS CMOS Setup Utility			
Main	Advanced	Power	Root Tools Exit
ACPI Suspend Type		[S1&S3]	Select Menu
ACPI APIC support		[Enabled]	Item Specific Help▶▶
▶	APM Configuration		Select the ACPI state used for System Suspend.
▶	Hardware Monitor		
F1: Help ↑↓ : Select Item -/+ : Change Value F5: Setup Defaults ESC: Exit ←→ : Select Menu Enter: Select SubMenu F10: Save and Exit			

3.5.1 ACPI Suspend Type [S1&S3]

Allows you to select the Advanced Configuration and Power Interface (ACPI) state to be used for system suspend.

Configuration options: [S1(POS)] [S3(STR)] [S1&S3]

3.5.2 ACPI APIC Support [Enabled]

Allows you to enable or disable the Advanced Configuration and Power Interface (ACPI) support in the Advanced Programmable Interrupt Controller (APIC). When set to [Enabled], the ACPI APIC table pointer is included in the RSDT pointer list.

Configuration options: [Disabled] [Enabled]

3.5.3 APM Configuration

Phoenix-Award BIOS CMOS Setup Utility			
Power			Select Menu
APM Configuration			Item Specific Help▶▶
Restore on AC Power Loss		[Power-Off]	Press [Enter] to select whether or not to restart the system after AC power loss
PWR Button < 4 secs		[Instant-Off]	
Power Up On PCI/PCIE Devices		[Disabled]	
Power On By External Modems		[Disabled]	
Power On by RTC Alarm		[Disabled]	
x	Date (of Month) Alarm	0	
x	Alarm Time (hh:mm)	0 : 0 : 0	
HPET Support		[Enabled]	
Power On By PS/2 Keyboard		[Disabled]	

Restore on AC Power Loss [Power-Off]

Allows you to enable or disable the Restore on AC Power Loss function.

Configuration options: [Power-Off] [Power-On] [Last State]

PWR Button < 4 secs [Instant-Off]

When set to [Instant-Off], the system goes into Soft-off mode after you press the power button for less than 4 seconds. When set to [Suspend], the system goes into Suspend mode after you press the power button for less than 4 seconds.
Configuration options: [Suspend] [Instant-Off]

Power Up On PCI/PCIE Devices [Disabled]

Allows you to enable or disable the PME to wake up from S5 by PCI/PCIE devices and the NVIDIA® onboard LAN.
Configuration options: [Disabled] [Enabled]

Power On By External Modems [Disabled]

When set to [Enabled], this item allows you to power on the computer in Soft-off mode with an external modem.
Configuration options: [Disabled] [Enabled]



When a computer is off, turning an external modem off and then on causes an initialization string that turns on the computer.

Power On By RTC Alarm [Disabled]

Allows you to enable or disable RTC to generate a wake event. When this item is set to [Enabled], the items **Date (of Month) Alarm** and **Alarm Time (hh:mm)** become user-configurable with set values.
Configuration options: [Disabled] [Enabled]

Date (of Month) Alarm [XX]

To set the date of alarm, highlight this item and press <Enter> to display the Date (of Month) Alarm pop-up menu. Key-in a value within the specified range then press <Enter>. Value '0' means everyday. Configuration options: [Min=0] [Max=31]

Alarm Time (hh:mm) [XX: XX: XX]

To set the time of alarm, highlight this item and press <Enter> to display the Alarm Time pop-up menu. Key-in a value within the specified range then press <Enter>.
Configuration options: [Min=0] [Max=23]---hour
 [Min=0] [Max=59]---minute
 [Min=0] [Max=59]---second

HPET Support [Enabled]

The hardware High Precision Efficient Timer (HPET) is to increase the performance of the Vista Multimedia player and can meet Vista's requirement. Disable this feature if your system is running under XP environment.
Configuration options: [Disabled] [Enabled]

Power Up By PS/2 Keyboard [Disabled]

Allows you to disable the Power On by PS/2 keyboard function or set specific keys on the PS/2 keyboard to turn on the system. This feature requires an ATX power supply that provides at least 1A on the +5VSB lead.

Configuration options: [Disabled] [Space Bar] [Ctrl-ESC] [Power Key]

3.5.4 Hardware Monitor

The items in this sub-menu displays the hardware monitor values automatically detected by the BIOS. It also allows you to change CPU Q-Fan feature-related parameters. Select an item then press <Enter> to display the configuration options.

Phoenix-Award BIOS CMOS Setup Utility	
Power	
Hardware Monitor	Select Menu
CPU Fan Type [DC]	Item Specific Help▶▶ Press [Enter] to enable or disable
CPU Q-Fan Control [Disabled]	
CPU Q-Fan Profile Performance	
Chassis Q-Fan Control [Disabled]	
Chassis Q-Fan Profile Performance	
Vcore Voltage [1.16V]	
3.3V Voltage [3.31V]	
5V Voltage [4.97V]	
12V Voltage [11.96V]	
CPU Temperature 39°C	
M/B Temperature 33°C	
CPU Fan Speed 2922 RPM	
CHA_FAN1 Speed 0 RPM	
CHA_FAN2 Speed 0 RPM	
PWR_FAN Speed 0 RPM	
CPU Fan Speed Warning [600 RPM]	

CPU Fan Type [DC]

Allows you to select the CPU fan type you installed on the motherboard.

Configuration options: [DC] [PWM]



- If you install a PWM (4-pin) fan but set this item to [DC], the fan you installed may not work.
- If you install a DC (3-pin) fan but set this item to a [PWM], the Q-Fan Control function will not work and the fan you install will always run at full speed.

CPU Q-Fan Control [Disabled]

Allows you to enable or disable the CPU Q-Fan controller.

Configuration options: [Disabled] [Enabled]



The **CPU Q-Fan Profile** item becomes user-configurable when you enable the CPU Q-Fan Control feature.

CPU Q-Fan Profile [Performance]

Allows you to set the appropriate performance level of the CPU Q-Fan. When set to [Optimal], the CPU fan automatically adjusts depending on the CPU temperature. Set this item to [Silent] to minimize fan speed for quiet CPU fan operation, or [Performance] to achieve maximum CPU fan speed.

Configuration options: [Performance] [Optimal] [Silent]

Chassis Q-Fan Control [Disabled]

Allows you to enable or disable the Chassis Q-Fan controller.

Configuration options: [Disabled] [Enabled]



The **Chassis Q-Fan Profile** item becomes user-configurable when you enable the Chassis Q-Fan Control feature.

Chassis Q-Fan Profile [Auto]

Allows you to set the appropriate performance level of the Chassis Q-Fan.

Configuration options: [Performance] [Optimal] [Silent]

Vcore Voltage, 3.3V Voltage, 5V Voltage, 12V Voltage

The onboard hardware monitor automatically detects the voltage output through the onboard voltage regulators. Select [Ignored] if you do not want to detect this item.

CPU Temperature [xxx°C/xxx°F]

M/B Temperature [xxx°C/xxx°F]

The onboard hardware monitor automatically detects and displays the motherboard and CPU temperatures. These items are not user-configurable.

CPU Fan Speed [xxxxRPM]

CHA_FAN1 Speed [xxxxRPM]

CHA_FAN2 Speed [xxxxRPM]

PWR_FAN Speed [xxxxRPM]

The onboard hardware monitor automatically detects and displays the CPU/Chassis/Power fan speed in rotations per minute (RPM). If the fan is not connected to the motherboard, the field shows 0 RPM. These items are not user-configurable.

CPU Fan Speed Warning [600 RPM]

Allows you to set the CPU fan warning speed function, which gives off a warning when the CPU fan speed is too low. If you set this item to [Disabled], the system will not warn you even if no fan is installed or if the fan is not functioning properly.

Configuration options: [Disabled] [600 RPM] [800 RPM] [1200 RPM]

3.6 Boot menu

The Boot menu items allow you to change the system boot options. Select an item then press <Enter> to display the sub-menu.

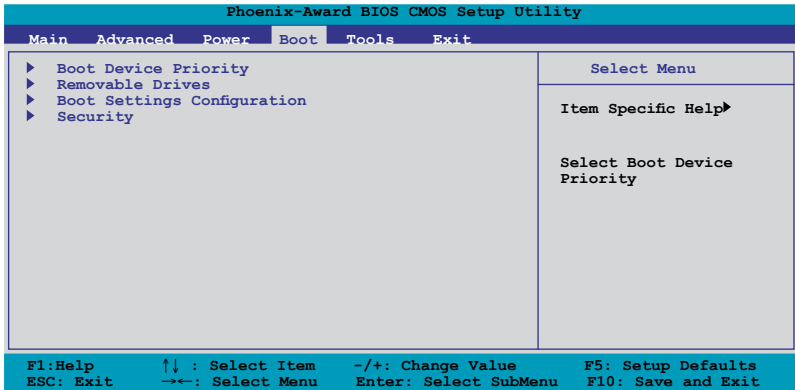

3.6.1 Boot Device Priority

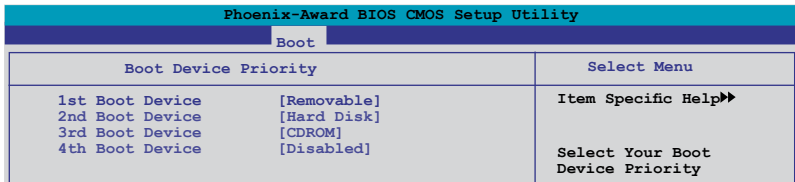

1st ~ 4th Boot Device [Removable]

These items specify the boot device priority sequence from the available devices. The number of device items that appears on the screen depends on the number of devices installed in the system.

Configuration options: [Removable] [Hard Disk] [CDROM] [Disabled]

3.6.2 Removable Drives

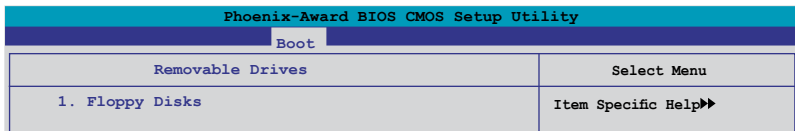

1. Floppy Disks

Allows you to assign a removable drive attached to the system.

3.6.3 Boot Settings Configuration

Phoenix-Award BIOS CMOS Setup Utility		
Boot		
Boot Settings Configuration		Select Menu
Case Open Warning	[Enabled]	Item Specific Help▶▶
Quick Boot	[Enabled]	Allows the system to skip certain tests while booting. This will decrease the time needed to boot the system
Boot Up Floppy Seek	[Disabled]	
Bootup Num-Lock	[On]	
Typematic Rate Setting	[Disabled]	
x Typematic Rate (Chars/Sec)	6	
x Typematic Delay (Msec)	250	
OS Select For DRAM > 64MB	[Non-OS2]	
Full Screen LOGO	[Enabled]	
Halt On	[All, But Keyboard]	

Case Open Warning [Enabled]

Enables or disables the chassis open status feature. Setting to [Enabled] to send warning messages when the chassis is opened.

Configuration options: [Disabled] [Enabled]

Quick Boot [Enabled]

Allows you to enable or disable the system quick boot feature. When Enabled, the system skips certain tests while booting.

Configuration options: [Disabled] [Enabled]

Boot Up Floppy Seek [Disabled]

Enable this item to run floppy drives test during POST to determine whether they have 40 or 80 tracks.

Configuration options: [Disabled] [Enabled]

Bootup Num-Lock [On]

Allows you to select the power-on state for the NumLock.

Configuration options: [Off] [On]

Typematic Rate Setting [Disabled]

Allows you to set the keystroke rate. Enable this item to configure the **Typematic Rate (Chars/Sec)** and the **Typematic Delay (Msec)** items.

Configuration options: [Disabled] [Enabled]

Typematic Rate (Chars/Sec) [6]

Allows you to select the rate at which a character repeats when you hold a key.

Configuration options: [6] [8] [10] [12] [15] [20] [24] [30]

Typematic Delay (Msec) [250]

Allows you to set the delay before keystrokes begin to repeat.

Configuration options: [250] [500] [750] [1000]

OS Select for DRAM > 64MB [Non-OS2]

Set this item to OS2 only when you are running on an OS/2 operating system with an installed RAM of greater than 64 MB.

Configuration options: [Non-OS2] [OS2]

Full Screen LOGO [Enabled]

This allows you to enable or disable the full screen logo display feature.

Configuration options: [Disabled] [Enabled]



Set this item to [Enabled] to use the ASUS MyLogo 2™ feature.

Halt On [All, But Keyboard]

Allows you to set the error report type.

Configuration options: [All Errors] [No Errors] [All, But Keyboard] [All, But Diskette] [All, But Disk/Key]

3.6.4 Security

Phoenix-Award BIOS CMOS Setup Utility		
Boot		
Security		Select Menu
Supervisor Password	Clear	Item Specific Help▶▶
User Password	Clear	
Password Check	[Setup]	

Supervisor Password

User Password

These fields allow you to set passwords:

To set a password:

1. Select an item then press <Enter>.
2. Type in a password using a combination of a maximum of eight (8) alpha-numeric characters, then press <Enter>.
3. When prompted, confirm the password by typing the exact characters again, then press <Enter>. The password field setting is changed to [Set].

To clear the password:

1. Select the password field and press <Enter> twice. The following message appears:

```
PASSWORD DISABLED !!!
Press any key to continue...
```

2. Press any key to continue. The password field setting is changed to [Clear].

A note about passwords

The Supervisor password is required to enter the BIOS Setup program preventing unauthorized access. The User password is required to boot the system preventing unauthorized use.

Forgot your password?

If you forget your password, you can clear it by erasing the CMOS Real Time Clock (RTC) RAM. The RAM data containing the password information is powered by the onboard button cell battery. If you need to erase the CMOS RAM, refer to section **2.6 Jumpers** for instructions.

Password Check

This field requires you to enter the password before entering the BIOS setup or the system. Select [Setup] to require the password before entering the BIOS Setup. Select [System] to require the password before entering the system.
Configuration options: [Setup] [System]

3.7 Tools menu

The Tools menu items allow you to configure options for special functions. Select an item then press <Enter> to display the sub-menu.

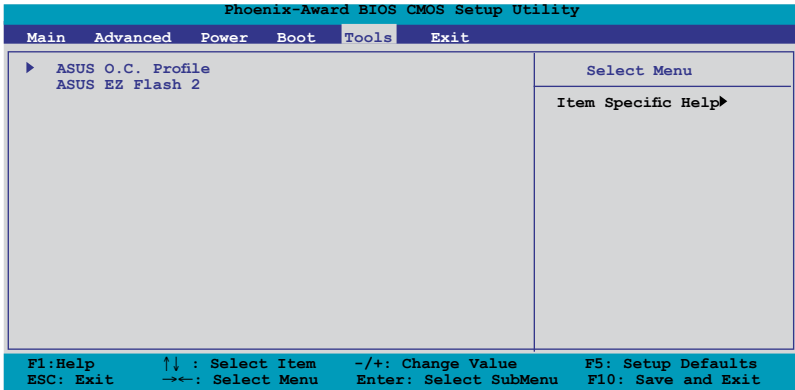

3.7.1 ASUS O.C. Profile

This item allows you to store or load multiple BIOS settings.

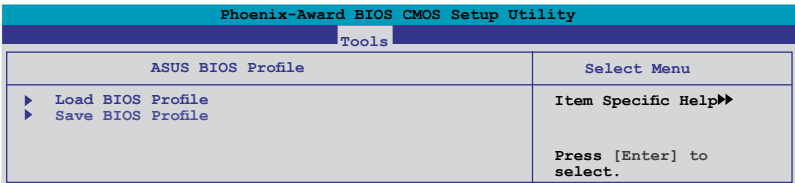

Load BIOS Profile

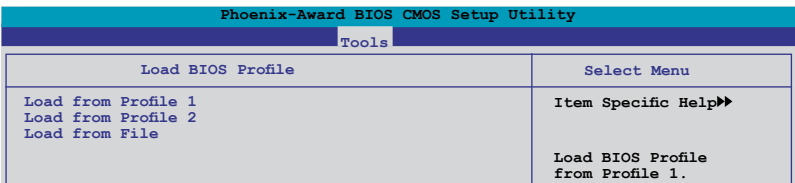

Load from Profile 1/2

Allows you to load the previous BIOS settings saved in the BIOS Flash. Press <Enter> to load the file.

Load from File

Allows you to load the previous BIOS file saved in the hard disk/floppy disk/USB flash disk with the FAT32/16/12 format. Follow the instructions below to load the BIOS file.

1. Insert the storage devices that contains the “xxx.CMO” file.
2. Turn on the system.
3. Enter BIOS setup program. Go to the “Tools” menu to select **ASUS O.C. Profile > Load from File**. Press <Enter> then the setup screen will appear.
4. Press <Tab> to switch between drives before the correct “xxx.CMO” file is found. Then press <Enter> to load the file.
5. A pop-up message will inform you when the loading process finishes.



- Suggest only to update the BIOS file coming from the same memory/CPU configuration and BIOS version.
- Only the “xxx.CMO” file can be loaded.

Save BIOS Profile

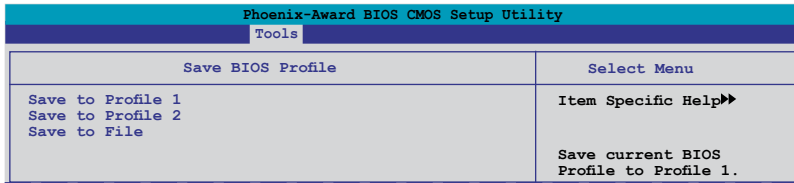

Save to Profile 1/2

Allows you to save the current BIOS file to the BIOS Flash. Press <Enter> to save the file.

Save to File

Allows you to save the current BIOS file to the hard disk/floppy disk/USB flash disk with FAT32/16/12 format. Follow the instructions below to save the BIOS file.

1. Insert the storage devices with enough space.
2. Turn on the system.
3. Enter the BIOS setup program. Go to the “Tools” menu to select “Save to File.” Press <Enter> then the setup screen will appear.
4. Press <Tab> to switch between the drives. Press hot-key <S> to save the file.
5. Key in the file name. Then press <Enter>.
6. A pop-up message will inform you when the saving process finishes.

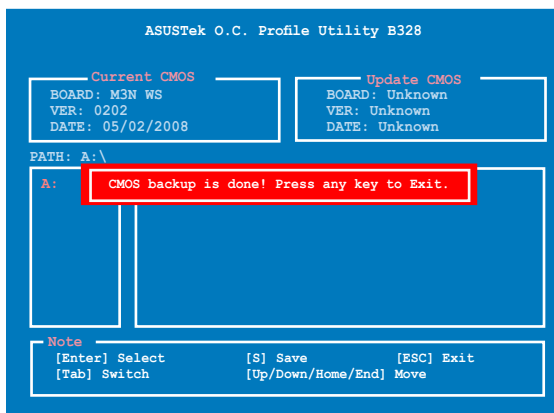

The BIOS file will be saved as “xxx.CMO”.

3.7.2 ASUS EZ Flash 2

Allows you to run ASUS EZ Flash 2. When you press <Enter>, a confirmation message appears. Use the left/right arrow key to select between [Yes] or [No], then press <Enter> to confirm your choice.

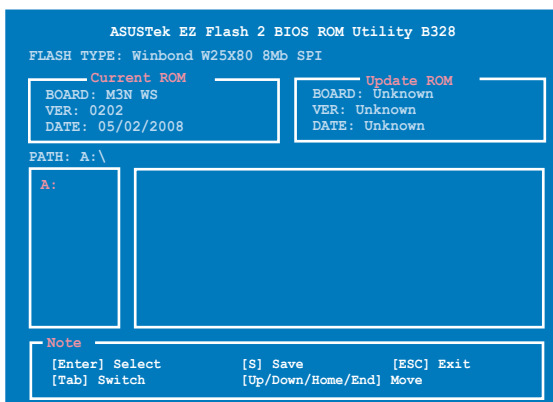

3.8 Exit menu

The Exit menu items allow you to load the optimal or failsafe default values for the BIOS items, and save or discard your changes to the BIOS items.

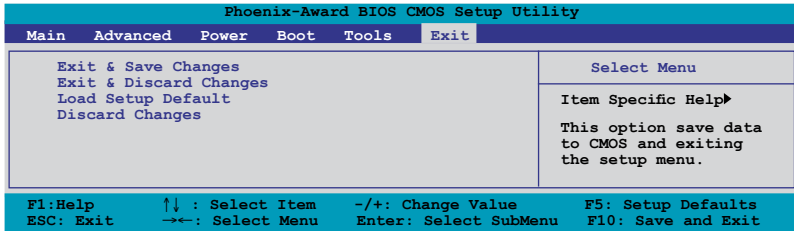

Pressing <Esc> does not immediately exit this menu. Select one of the options from this menu or <F10> from the legend bar to exit.

Exit & Save Changes

Once you are finished making your selections, choose this option from the Exit menu to ensure the values you selected are saved to the CMOS RAM. An onboard backup battery sustains the CMOS RAM so it stays on even when the PC is turned off. When you select this option, a confirmation window appears. Select YES to save changes and exit.



If you attempt to exit the Setup program without saving your changes, the program prompts you with a message asking if you want to save your changes before exiting. Press <Enter> to save the changes while exiting.

Exit & Discard Changes

Select this option only if you do not want to save the changes that you made to the Setup program. If you made changes to fields other than System Date, System Time, and Password, the BIOS asks for a confirmation before exiting.

Load Setup Default

This option allows you to load the default values for each of the parameters on the Setup menus. When you select this option or if you press <F5>, a confirmation window appears. Select YES to load default values. Select Exit & Save Changes or make other changes before saving the values to the non-volatile RAM.

Discard Changes

This option allows you to discard the selections you made and restore the previously saved values. After selecting this option, a confirmation appears. Select YES to discard any changes and load the previously saved values.

This chapter describes the contents of the support DVD that comes with the motherboard package.

4 Software support

4.1	Installing an operating system	4-1
4.2	Support DVD information	4-1
4.3	Software information	4-9
4.4	RAID configurations	4-35
4.5	Creating a RAID driver disk.....	4-43

4.1 Installing an operating system

This motherboard supports Windows® XP/64-bit XP/Vista/64-bit Vista operating systems (OS). Always install the latest OS version and corresponding updates to maximize the features of your hardware.



- Motherboard settings and hardware options vary. Use the setup procedures presented in this chapter for reference only. Refer to your OS documentation for detailed information.
- Make sure that you install Windows® 2000 Service Pack 4 or the Windows® XP Service Pack 2 or later versions before installing the drivers for better compatibility and system stability.

4.2 Support DVD information

The support DVD that came with the motherboard package contains the drivers, software applications, and utilities that you can install to avail all motherboard features.



The contents of the support DVD are subject to change at any time without notice. Visit the ASUS website(www.asus.com) for updates.

4.2.1 Running the support DVD

Place the support DVD to the optical drive. The DVD automatically displays the Drivers menu if Autorun is enabled in your computer.



Click an icon to display support DVD/motherboard information

Click an item to install



If Autorun is NOT enabled in your computer, browse the contents of the support DVD to locate the file ASSETUP.EXE from the BIN folder. Double-click the ASSETUP.EXE to run the DVD.

4.2.2 Drivers menu

The drivers menu shows the available device drivers if the system detects installed devices. Install the necessary drivers to activate the devices.



ASUS InstAll - Installation Wizard for Anti-Virus and Drivers Utility

Installs all of the drivers and anti-virus utility through the installation wizard.

NVIDIA Chipset Driver Program

Installs the NVIDIA® chipset drivers for the NVIDIA GeForce 8200 chipset.

Realtek Audio Driver

Installs the Realtek® ALC888 audio driver and application.

AMD Cool 'n' Quiet Driver (Windows® XP only)

Installs the AMD® Cool 'n' Quiet™ technology driver.

Realtek RTL8111C LAN Driver

Installs the Realtek® RTL8111C LAN driver.

NVIDIA Hybrid SLI Driver

Installs the NVIDIA® Hybrid SLI Driver. This item appears only when you are running Windows Vista® OS.



Uninstall the onboard NVIDIA display driver BEFORE installing the Hybrid SLI driver.

NVIDIA HDMI Audio Driver

Installs the NVIDIA® HDMI audio driver.

4.2.3 Utilities menu

The Utilities menu shows the applications and other software that the motherboard supports.



Click to display the next page

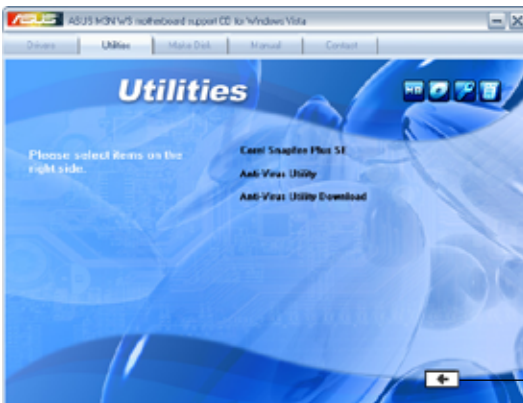

Click to return to the previous page

ASUS InstAll - Installation Wizard for Utilities

Installs all of the utilities through the Installation Wizard.

ASUS Cool'n'Quiet Utility

This item installs the ASUS Cool'n'Quiet utility.

ASUS PC Probe II

This smart utility monitors the fan speed, CPU temperature, and system voltages, and alerts you of any detected problems. This utility helps you keep your computer in healthy operating condition.

ASUS Update

Allows you to download the latest version of the BIOS from the ASUS website.



Before using the ASUS Update, make sure that you have an Internet connection so you can connect to the ASUS website.

ASUS AI Suite

Installs the ASUS AI Suite.

Adobe Acrobat Reader 8

Installs the Adobe® Acrobat® Reader that allows you to open, view, and print documents in Portable Document Format (PDF).

Realtek Teaming Utility

Installs the Realtek LAN Teaming Utility.

InterVideo WinDVD 8 Trial

Installs the InterVideo WinDVD 8 Trial to enjoy your DVD entertainment.

Ulead PhotoImpact 12 SE

Installs the PhotoImpact image editing software.

CyberLink PowerBackup

Installs CyberLink PowerBackup to back up and restore your data easily.

Corel Snapfire Plus SE

Installs Corel Snapfire Plus SE.

Anti-Virus Utility

The anti-virus application detects and protects your computer from viruses that destroys data.

Anti-Virus Utility Download

Updates your anti-virus utility version.

4.2.4 Make Disk menu

The Make Disk menu contains items to create the NVIDIA® GeForce™ 8200 SATA/RAID driver disk.



Click to display the next page

Click to return to the previous page

NVIDIA 32/64bit XP SATA RAID Driver (Disk 1/2)

Allows you to create NVIDIA SATA RAID driver disks for 32/64bit Windows® XP.

NVIDIA 32/64bit XP AHCI Driver (Disk 1/2)

Allows you to create an NVIDIA AHCI driver disk for 32/64bit Windows® XP.



Due to floppy disc capacity limitation, when creating a RAID configuration under 32/64bit Windows® Vista, please install the AHCI/RAID driver through the motherboard support DVD or a USB device.

Find RAID driver in the support DVD through the path below:

Drivers\Chipset\Disk\RAID

Find AHCI driver in the support DVD through the path below:

Drivers\Chipset\Disk\AHCI

4.2.5 Manual menu

The Manual menu contains a list of supplementary user manuals. Click an item to open the folder of the user manual.



Most user manual files are in Portable Document Format (PDF). Install the Adobe® Acrobat® Reader from the Utilities menu before opening a user manual file.



4.2.6 ASUS Contact information

Click the Contact tab to display the ASUS contact information. You can also find this information on the inside front cover of this user guide.

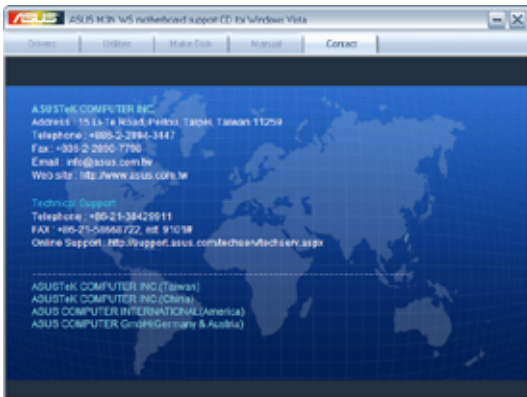

Technical support Form

Displays the ASUS Technical Support Request Form that you have to fill out when requesting technical support.

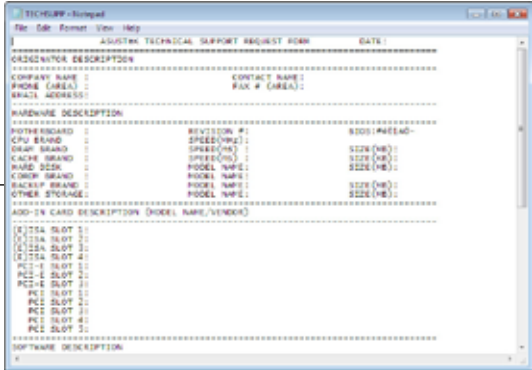

File list

Displays the contents of the support DVD and a brief description of each in text format.

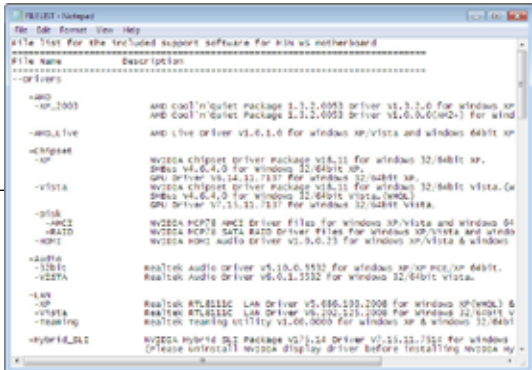

- When the logo images appear on the right window pane, select an image to enlarge by clicking on it.



- Adjust the boot image to your desired size by selecting a value on the Ratio box.



- When the screen returns to the ASUS Update utility, flash the original BIOS to load the new boot logo.
- After flashing the BIOS, restart the computer to display the new boot logo during POST.

4.3.2 Cool 'n' Quiet!™ Technology

The motherboard supports the AMD Cool 'n' Quiet!™ Technology that dynamically and automatically change the CPU speed, voltage, and amount of power depending on the task the CPU performs.

Enabling Cool 'n' Quiet!™ Technology

To enable Cool 'n' Quiet!™ Technology:

1. Turn on the system and enter BIOS by pressing the key during the Power On Self-Tests (POST).
2. Go to **Advanced > CPU Configuration > AMD Cool 'n'Quiet Function** and set it to [Enabled]. See section 3.4 **Advanced menu**.
3. Save your changes and exit BIOS Setup.
4. Reboot your computer and set your Power Option Properties depending on your operating system.

Windows® XP

1. From the Windows® XP operating system, click **Start**. Select **Settings > Control Panel**.
2. Make sure the Control Panel is set to **Classic View**.
3. Double-click the **Display** icon in the Control Panel then select the **Screen Saver** tab.
4. Click the **Power** button. The following dialogue box appears.
5. From the Power schemes combo list box, select **Minimal Power Management**.
6. Click **OK** to effect settings.

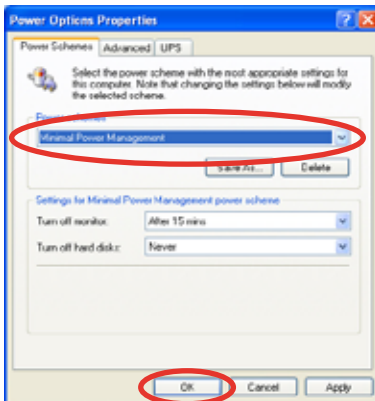

Windows® Vista

1. From the Windows® Vista operating system, click **Start**. Select **Control Panel**.
2. Make sure the Control Panel is set to **Classic View**.
3. Double-click the **Personalization** icon in the Control Panel then click the **Screen Saver** item.
4. Click “**Change power settings...**”. The following dialogue box appears.
5. From the Preferred plans, select **Power saver**.
6. Close all windows.

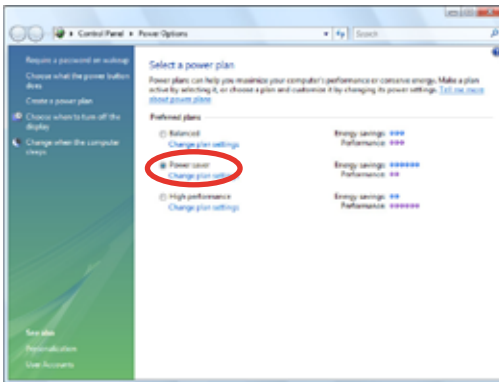

- Make sure to install the AMD Cool 'n' Quiet!™ driver and application before using this feature.
- The AMD Cool 'n' Quiet!™ technology feature works only with the AMD heatsink and fan assembly with monitor chip
- If you purchased a separate heatsink and fan package, use the ASUS Q-Fan technology feature to automatically adjust the CPU fan speed according to your system loading.

Launching the Cool 'n' Quiet!™ software

The motherboard support CD/DVD includes the Cool 'n' Quiet!™ software that enables you to view your system's real-time CPU Frequency and voltage.



Make sure to install the Cool 'n' Quiet!™ software from the motherboard support CD/DVD. Refer to section **4.2.3 Utilities menu** for details.

To launch the Cool 'n' Quiet!™ program:

1. If you are using Windows® XP, click the **Start** button. Select **Programs > ASUS > Cool & Quiet > Cool & Quiet**.
2. If you are using Windows® Vista, click the **Start** button. Select **All Programs > ASUS > Cool & Quiet > Cool & Quiet**.
3. The Cool 'n' Quiet!™ technology screen appears and displays the current CPU Frequency and CPU Voltage.

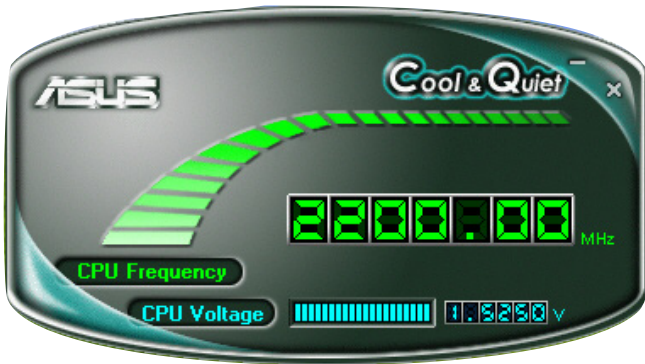

4.3.3 Audio configurations

The Realtek® audio CODEC provides 8-channel audio capability to deliver the ultimate audio experience on your computer. The software provides Jack-Sensing function, S/PDIF Out support, and interrupt capability. The CODEC also includes the Realtek® proprietary UAJ® (Universal Audio Jack) technology for all audio ports, eliminating cable connection errors and giving users plug and play convenience.

Follow the installation wizard to install the Realtek® Audio Driver from the support CD/DVD that came with the motherboard package.

If the Realtek audio software is correctly installed, you will find the **Realtek HD Audio Manager** icon on the taskbar.

From the taskbar, double-click on the SoundEffect icon to display the Realtek HD Audio Manager.



Realtek HD Audio Manager

A. Realtek HD Audio Manager for Windows Vista™



Information

Click the **Information** button () to display information about the audio driver version, DirectX version, audio controller, audio codec, and language setting.

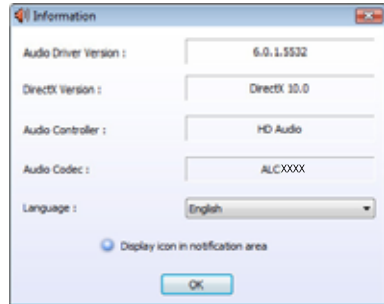

Device advanced settings

Click **Device advanced settings** to show further settings for the playback and recording device.

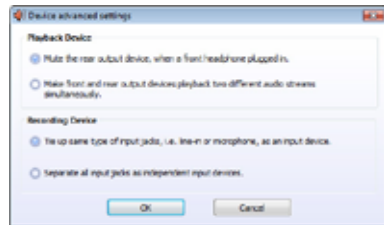

Connector settings

Click the **Connector Settings** button () to show further settings for the analog/digital output/input ports.

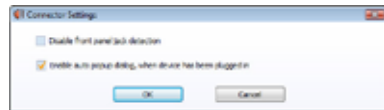

Exit

Click the **Exit** button or the **OK** button () to exit the Realtek HD Audio Manager.

Configuration options

Click any of the tabs in this area to configure your audio settings.



The Configuration options shown in this section are for reference purposes only and may not exactly match what you see on your screen. In the Windows Vista™ environment, Realtek HD Audio Manager automatically detects devices connected to the analog/digital ports and shows corresponding configuration options tabs.

Digital Output

The Realtek® audio CODEC allows you to connect an external audio output device via the coaxial/digital S/PDIF port. You can set your listening environment, set the karaoke, or select pre-programmed equalizer settings for your listening pleasure.

To set the digital output options

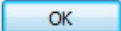
1. From the Realtek HD Audio Manager, click the **Digital Output** tab.
2. Click **Set Default Device** to set the digital output port as the default audio output device.
3. Click the **Sound Effects** sub-tab for options on changing the acoustic environment and karaoke settings, or click the **Default Format** sub-tab for options on changing the default audio output format.
4. Click  to effect the Digital Output settings and exit.



Speakers

The **Speakers** tab allows you to configure audio output settings using the analog audio ports.

To set the speakers options

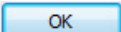
1. From the Realtek HD Audio Manager, click the **Speakers** tab.
2. Click **Set Default Device** to set the analog ports as the default audio output device.
3. Click the **Speaker Configuration** sub-tab for audio channel options and test.
4. Click the **Sound Effects** sub-tab for options on changing the acoustic environment and karaoke settings.
5. Click the **Room Correction** sub-tab for individual speaker distance adjustment.
6. Click the **Default Format** sub-tab for options on changing the default audio output format.
7. Click  to effect the Speakers settings and exit.



Line In

The **Line In** tab allows you to configure audio input settings using the analog line in port.

To set the analog line in options

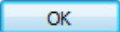
1. From the Realtek HD Audio Manager, click the **Line In** tab.
2. Click **Set Default Device** to set the analog line in port as the default audio input device.
3. The Line In tab allows you to adjust the recording and playback volume and set a default format for audio input.
4. Click  to effect the Line In settings and exit.

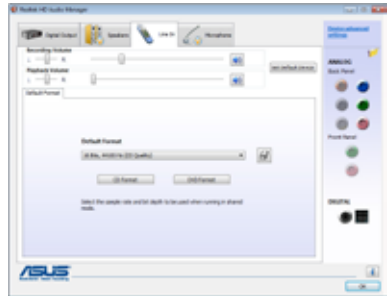

Microphone

The **Microphone** tab allows you to configure the audio input settings using the analog microphone port and to check if your microphone device is connected properly.

To set the Microphone options

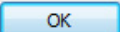
1. From the Realtek HD Audio Manager, click the **Microphone** tab.
2. In the **Microphone Effects** sub-tab, click the **Noise Suppression** option button to reduce the static background noise when recording. Click the **Acoustic Echo Cancellation** option button to reduce the echo from the front speakers when recording. Click the **Beam Forming** option button to eliminate surrounding noise interferences.
3. Click the **Default Format** sub-tab for options on changing the default audio input format.
4. Click  to effect the Microphone settings and exit.



B. Realtek HD Audio Manager for Windows XP™



Information

Click the information button () to display information about the audio driver version, DirectX version, audio controller, audio codec, and language setting.



Minimize

Click the minimize button () to minimize the window.

Exit

Click the exit button () to exit the Realtek HD Audio Manager.

Configuration options

Click any of the tabs in this area to configure your audio settings.

Sound Effect

The Realtek® audio CODEC allows you to set your listening environment, adjust the equalizer, set the karaoke, or select pre-programmed equalizer settings for your listening pleasure.

To set the sound effect options

1. From the Realtek HD Audio Manager, click the **Sound Effect** tab.
2. Click the shortcut buttons or the drop-down menus for options on changing the acoustic environment, adjust the equalizer, or set the karaoke to your desired settings.
3. Click  to effect the Sound Effect settings and exit.



Mixer

The Mixer option allows you to configure audio output (playback) volume and audio input (record) volume.

To set the mixer options

1. From the Realtek HD Audio Manager, click the **Mixer** tab.
2. Turn the volume buttons to adjust the Playback and/or Record volume.



The Mixer option activates voice input from all channels by default. Make sure to set all channels to mute () if you do not want voice input.

3. Make adjustments to Wave, SW Synth, Front, Rear, CD volume, Mic volume, Line Volume, and Stereo mix, etc. by clicking the control tabs and dragging them up and down until you get the desired levels.



Click the next button () to display more menu options.

4. Click  to effect the Mixer settings and exit.

Audio I/O

The Audio I/O option allows you configure your input/output settings.

To set the Audio I/O options

1. From the Realtek HD Audio Manager, click the **Audio I/O** tab.
2. Click the drop-down menu to select the channel configuration.
3. The control settings window displays the status of connected devices. Click  for analog and digital options.
4. Click <OK> to effect the Audio I/O settings and exit



Microphone

The Microphone option allows you configure your input/output settings and to check if your audio devices are connected properly.

To set the Microphone options



1. From the Realtek HD Audio Manager, click the **Microphone** tab.
2. Click the **Noise Suppression** option button to reduce the static background noise when recording.
3. Click the **Acoustic Echo Cancellation** option button to reduce the echo from the front speakers when recording.
4. Click the **Beam Forming** option button to eliminate surrounding noise interferences. Click  to start microphone calibration.
5. Click  to effect the Microphone settings and exit.



3D Audio Demo

The 3D Audio Demo option gives you a demonstration of the 3D audio feature.

To start the 3D Audio Demo

1. From the Realtek HD Audio Manager, click the **3D Audio Demo** tab.
2. Click the option buttons to change the sound, moving path, or environment settings.
3. Click  to test your settings.
4. Click  to effect the 3D Audio Demo settings and exit.



4.3.4 ASUS PC Probe II

PC Probe II is a utility that monitors the computer's vital components, and detects and alerts you of any problem with these components. PC Probe II senses fan rotations, CPU temperature, and system voltages, among others. Because PC Probe II is software-based, you can start monitoring your computer the moment you turn it on. With this utility, you are assured that your computer is always at a healthy operating condition.

Installing PC Probe II

To install PC Probe II on your computer:

1. Place the support DVD to the optical drive. The Drivers installation tab appears if your computer has an enabled Autorun feature.



If Autorun is not enabled in your computer, browse the contents of the support DVD to locate the setup.exe file from the ASUS PC Probe II folder. Double-click the **setup.exe** file to start installation.

2. Click the **Utilities** tab, then click **ASUS PC Probe II**.
3. Follow the screen instructions to complete installation.

Launching PC Probe II

You can launch the PC Probe II right after installation or anytime from the Windows® desktop.

To launch the PC Probe II from the Windows® desktop, click **Start > All Programs > ASUS > PC Probe II > PC Probe II v1.xx.xx**. The PC Probe II main window appears.

After launching the application, the PC Probe II icon appears in the Windows® taskbar. Click this icon to close or restore the application.









Using PC Probe II

Main window

The PC Probe II main window allows you to view the current status of your system and change the utility configuration. By default, the main window displays the Preference section. You can close or restore the Preference section by clicking on the triangle on the main window right handle.



Click to close the Preference panel

Button	Function
	Opens the Configuration window
	Opens the Report window
	Opens the Desktop Management Interface window
	Opens the Peripheral Component Interconnect window
	Opens the Windows Management Instrumentation window
	Opens the hard disk drive, memory, CPU usage window
	Shows/Hides the Preference section
	Minimizes the application
	Closes the application

Sensor alert

When a system sensor detects a problem, the main window right handle turns red, as the illustrations below show.



When displayed, the monitor panel for that sensor also turns red. Refer to the Monitor panels section for details.

Preference

You can customize the application using the Preference section in the main window. Click the box before each preference to activate or deactivate.

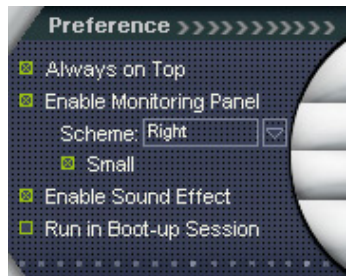

Hardware monitor panels

The hardware monitor panels display the current value of a system sensor such as fan rotation, CPU temperature, and voltages.

The hardware monitor panels come in two display modes: hexagonal (large) and rectangular (small). When you check the Enable Monitoring Panel option from the Preference section, the monitor panels appear on your computer's desktop.



Large display



Small display

Changing the monitor panels position

To change the position of the monitor panels in the desktop, click the arrow down button of the Scheme options, then select another position from the list box. Click OK when finished.





Moving the monitor panels

All monitor panels move together using a magnetic effect. If you want to detach a monitor panel from the group, click the horseshoe magnet icon. You can now move or reposition the panel independently.



Adjusting the sensor threshold value

You can adjust the sensor threshold value in the monitor panel by clicking the  or  buttons. You can also adjust the threshold values using the Config window.

You cannot adjust the sensor threshold values in a small monitoring panel.

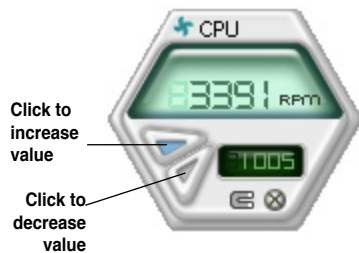

Monitoring sensor alert

The monitor panel turns red when a component value exceeds or is lower than the threshold value. Refer to the illustrations below.



Large display



Small display

WMI browser

Click **WMI** to display the WMI (Windows Management Instrumentation) browser. This browser displays various Windows® management information. Click an item from the left panel to display on the right panel. Click the plus sign (+) before WMI Information to display the available information.



You can enlarge or reduce the browser size by dragging the bottom right corner of the browser.

DMI browser

Click **DMI** to display the DMI (Desktop Management Interface) browser. This browser displays various desktop and system information. Click the plus sign (+) before DMI Information to display the available information.



PCI browser

Click **PCI** to display the PCI (Peripheral Component Interconnect) browser. This browser provides information on the PCI devices installed on your system. Click the plus sign (+) before the PCI Information item to display available information.

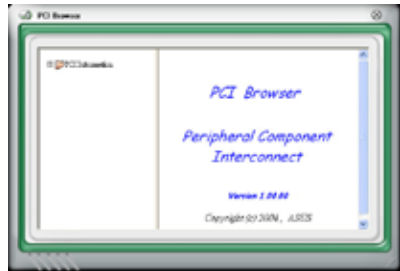

Usage

The Usage browser displays real-time information on the CPU, hard disk drive space, and memory usage. Click **USAGE** to display the Usage browser.

CPU usage

The CPU tab displays real-time CPU usage in line graph representation. If the CPU has an enabled Hyper-Threading, two separate line graphs display the operation of the two logical processors.

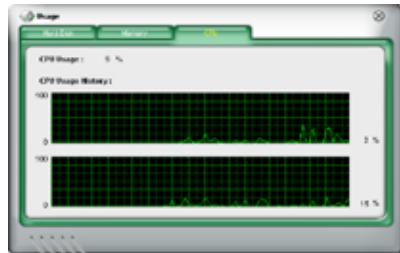

Hard disk drive space usage

The Hard Disk tab displays the used and available hard disk drive space. The left panel of the tab lists all logical drives. Click a hard disk drive to display the information on the right panel. The pie chart at the bottom of the window represents the used (blue) and the available HDD space.



Memory usage

The Memory tab shows both used and available physical memory. The pie chart at the bottom of the window represents the used (blue) and the available physical memory.



Configuring PC Probe II

Click **CONFIG** to view and adjust the sensor threshold values.

The Config window has two tabs: Sensor/Threshold and Preference. The Sensor/Threshold tab enables you to activate the sensors or to adjust the sensor threshold values. The Preference tab allows you to customize sensor alerts, or change the temperature scale.

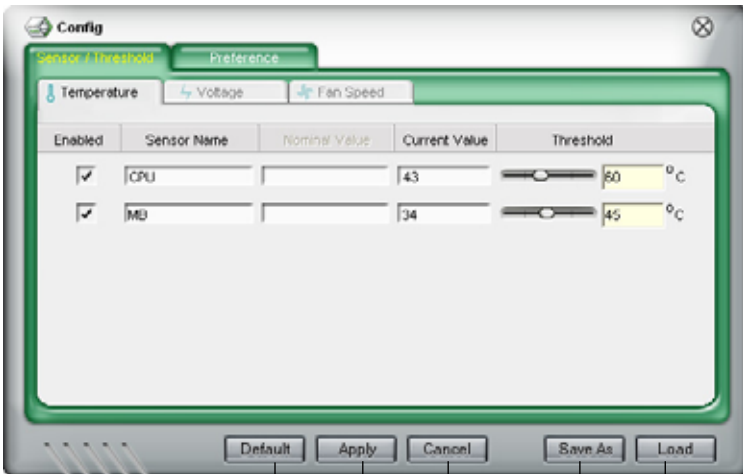

Loads the default threshold values for each sensor

Applies your changes

Cancels or ignores your changes

Loads your saved configuration

Saves your configuration

4.3.5 ASUS AI Suite

ASUS AI Suite allows you to launch AI Gear2, AI N.O.S., AI Booster, AI Nap, and Q-Fan2 utilities easily.

Installing AI Suite

To install AI Suite on your computer:

1. Place the support DVD to the optical drive. The Drivers installation tab appears if your computer has an enabled Autorun feature.
2. Click the Utilities tab, then click **AI Suite**.
3. Follow the screen instructions to complete installation.

Launching AI Suite

You can launch the AI Suite right after installation or anytime from the Windows® desktop.

To launch the AI Suite from the Windows® desktop, click **Start > All Programs > ASUS > AI Suite > AI Suite v1.xx.xx**. The AI Suite main window appears.

After launching the application, the AI Suite icon appears in the Windows® taskbar. Click this icon to close or restore the application.

Using AI Suite

Click the AI N.O.S., AI Gear2, AI Nap, AI Booster, or Q-Fan2 icon to launch the utility, or click the Normal icon to restore the system to normal state.

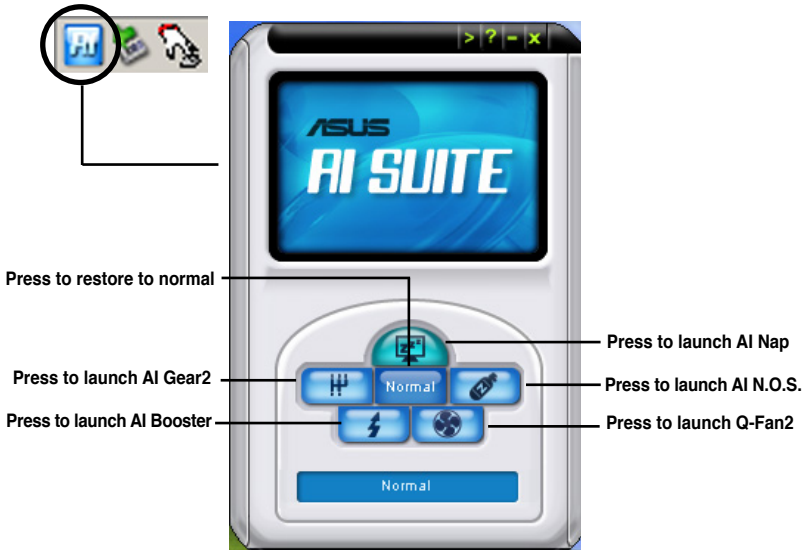

Other feature buttons

Click  on right corner of the main window to open the monitor window.

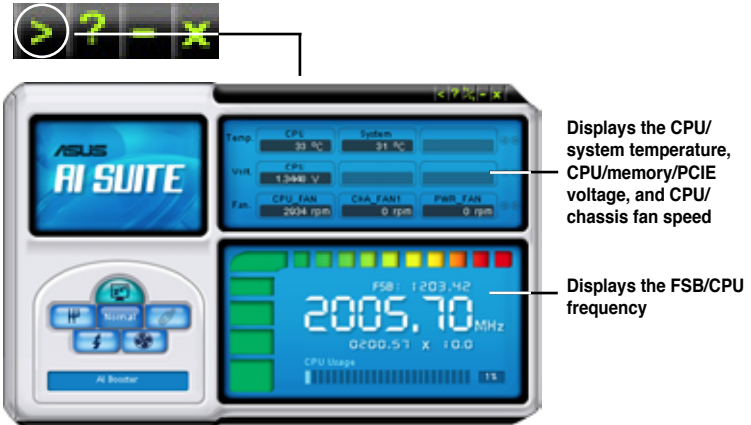

Click  on right corner of the expanded window to switch the temperature from degrees Centigrade to degrees Fahrenheit.



4.3.6 ASUS AI Gear 2

ASUS AI Gear 2 provides four system performance options that allows you to select the best performance setting for your computing needs. This easy-to-use utility adjusts the processor frequency and vCore voltage to minimize system noise and power consumption.

After installing AI Suite from the bundled support DVD, you can launch AI Gear 2 by double-clicking the AI Suite icon on your Windows OS taskbar and then click the AI Gear 2 button on the AI Suite main window.

Shift the gear to the performance setting that you like.

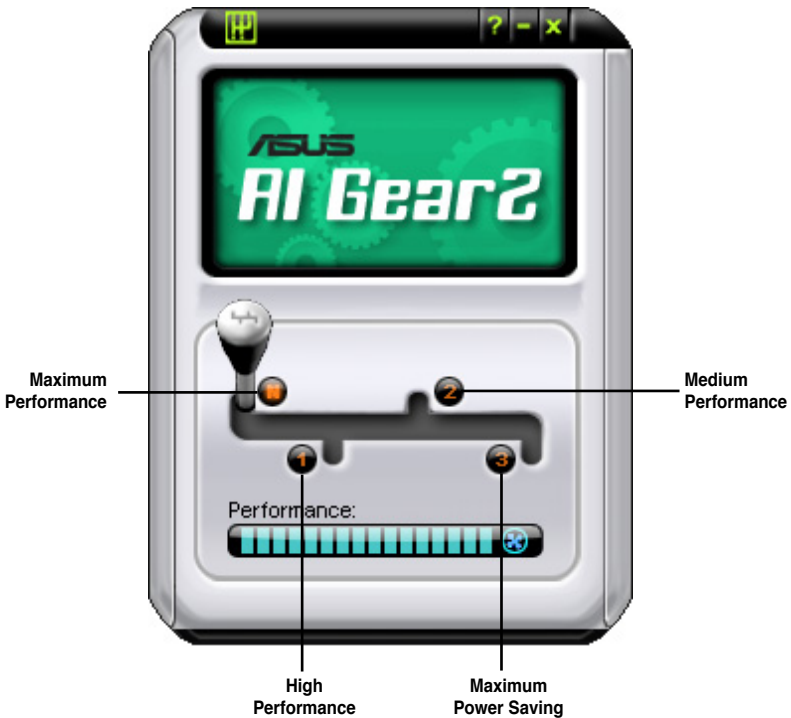

4.3.7 ASUS AI Nap

This feature allows you to minimize the power consumption of your computer whenever you are away. Enable this feature for minimum power consumption and a more quiet system operation.

After installing AI Suite from the bundled support DVD, you can launch the utility by double-clicking the AI Suite icon on the Windows OS taskbar and click the AI Nap button on the AI Suite main window.

Click **Yes** on the confirmation screen.

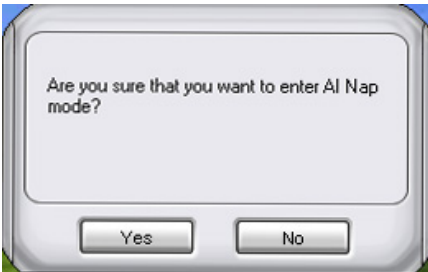

To exit AI Nap mode, press the system power or mouse button then click **Yes** on the confirmation screen.

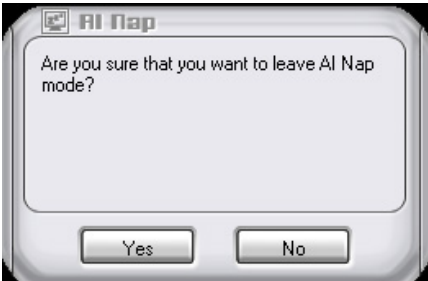

To switch the power button functions from AI Nap to shutting down, just right click the **AI Suite** icon on the OS taskbar, select **AI Nap** and click **Use power button**. Unclick the the item to switch the function back.

4.3.8 ASUS AI N.O.S.

This ASUS Non-delay Overclocking System feature intelligently determines the system load and automatically boosts the performance for the most demanding tasks.

After installing AI Suite from the bundled support CD, you can launch the utility by double-clicking the AI Suite icon on the Windows OS taskbar and click the AI N.O.S. button on the AI Suite main window.

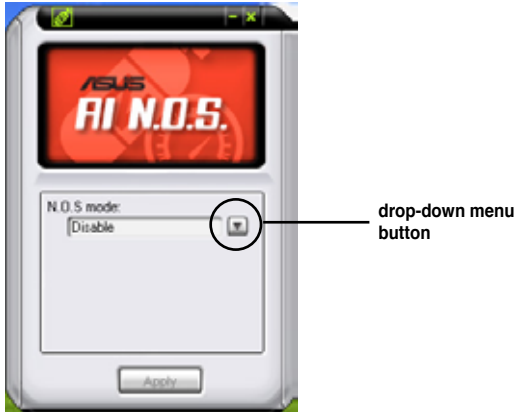

Click the drop-down menu button and select **Disable** or **Manual**.

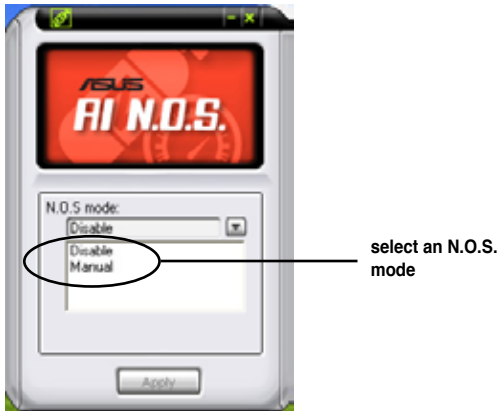

Click **Apply** at the bottom to save the configuration.

4.3.9 ASUS Q-Fan 2

This ASUS Q-Fan 2 Control feature allows you to set the appropriate performance level of the CPU Q-Fan 2 or the Chassis Q-Fan 2 for more efficient system operation. After enabling the Q-Fan 2 function, the fans can be set to automatically adjust depending on the temperature, to decrease fan speed, or to achieve the maximum fan speed.

After installing AI Suite from the bundled support DVD, you can launch the utility by double-clicking the AI Suite icon on the Windows® OS taskbar and click the Q-Fan 2 button on the AI Suite main window.

Click the drop-down menu button and display the fan names. Select **CPU Q-Fan 2** or **CHASSIS Q-Fan 2**. Click the box of **Enable Q-Fan 2** to activate this function.



Profile list appears after clicking the **Enable Q-Fan 2** box. Click the drop-down list button and select a profile. **Optimal** mode makes the fans adjust speed with the temperature; **Silent** mode minimizes fan speed for quiet fan operation; **Performance** mode boosts the fan to achieve maximal fan speed for the best cooling effect.

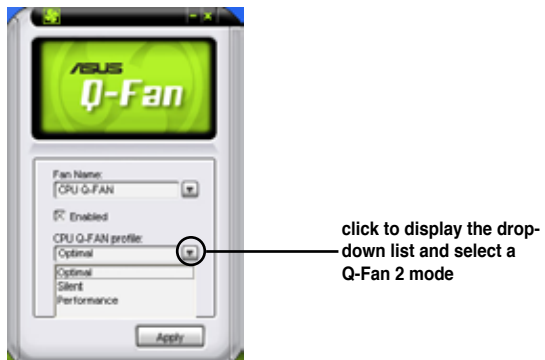

Click **Apply** at the bottom to save the setup.

4.3.10 ASUS AI Booster

The ASUS AI Booster application allows you to overclock the CPU speed in Windows® environment without the hassle of booting the BIOS.

After installing AI Suite from the bundled support DVD, you can launch the utility by double-clicking the AI Suite icon on the Windows® OS taskbar and click the AI Booster button on the AI Suite main window.

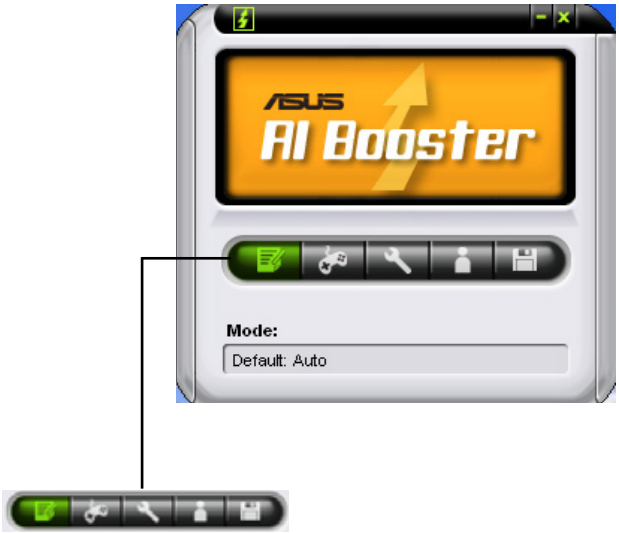

The options on the taskbar allow you to use the default settings, adjust CPU/ Memory/PCI-E frequency manually, or create and apply your personal overclocking configurations.

4.4 RAID configurations

The motherboard comes with the NVIDIA GeForce 8200 chipset that allows you to configure Serial ATA hard disk drives as RAID sets. The motherboard supports the following RAID configurations: RAID 0, RAID 1, RAID 0+1, RAID 5 and JBOD.

4.4.1 RAID definitions

RAID 0 (*Data striping*) optimizes two identical hard disk drives to read and write data in parallel, interleaved stacks. Two hard disks perform the same work as a single drive but at a sustained data transfer rate, double that of a single disk alone, thus improving data access and storage. Use of two new identical hard disk drives is required for this setup.

RAID 1 (*Data mirroring*) copies and maintains an identical image of data from one drive to a second drive. If one drive fails, the disk array management software directs all applications to the surviving drive as it contains a complete copy of the data in the other drive. This RAID configuration provides data protection and increases fault tolerance to the entire system. Use two new drives or use an existing drive and a new drive for this setup. The new drive must be of the same size or larger than the existing drive.

RAID 0+1 is data striping and data mirroring combined without parity (redundancy data) having to be calculated and written. With the RAID 0+1 configuration you get all the benefits of both RAID 0 and RAID 1 configurations. Use four new hard disk drives or use an existing drive and three new drives for this setup.

RAID 5 stripes both data and parity information across three or more hard disk drives. Among the advantages of RAID 5 configuration include better HDD performance, fault tolerance, and higher storage capacity. The RAID 5 configuration is best suited for transaction processing, relational database applications, enterprise resource planning, and other business systems. Use a minimum of three identical hard disk drives for this setup.

JBOD (*Spanning*) stands for Just a Bunch of Disks and refers to hard disk drives that are not yet configured as a RAID set. This configuration stores the same data redundantly on multiple disks that appear as a single disk on the operating system. Spanning does not deliver any advantage over using separate disks independently and does not provide fault tolerance or other RAID performance benefits.



For Windows XP, If you want to boot the system from a hard disk drive included in a RAID set, first copy the RAID driver from the support DVD to a floppy disk before you install an operating system to a selected hard disk drive. Refer to section 4.5 **Creating a RAID driver disk** for details.

4.4.2 NVIDIA® RAID configurations

The motherboard includes a high performance SATA RAID controller integrated in the NVIDIA® GeForce 8200 chipset. It supports RAID 0, RAID 1, RAID 0+1, RAID 5 and JBOD for six independent Serial ATA channels.

Installing Serial ATA (SATA) hard disks

The motherboard supports Ultra DMA 133/100/66 and Serial ATA hard disk drives. For optimal performance, install identical drives of the same model and capacity when creating a disk array.

To install the SATA hard disks for a RAID configuration:

1. Install the SATA hard disks into the drive bays.
2. Connect the SATA signal cables.
3. Connect a SATA power cable to the power connector on each drive.



Refer to the RAID controllers user manual in the motherboard support DVD for detailed information on RAID configurations. See section **4.2.5 Manuals menu**.

Setting the BIOS RAID items

After installing the hard disk drives, make sure to set the necessary RAID items in the BIOS before setting your RAID configuration.

To set the BIOS RAID items:

1. Boot the system and press during the Power-On Self-Test (POST) to enter the BIOS Setup Utility.
2. Set the **SATA Operation Mode** item to [RAID]. See section **3.4.6 Onboard Device Configuration > MCP Storage Config** for details.
3. Save your changes and Exit Setup.



- Due to chipset limitation, when set any of SATA ports to RAID mode, all SATA ports run at RAID mode together.
 - Make sure to re-enter your NVRAID settings after the CMOS is cleared; otherwise, the system will not recognize your RAID setup.
-



When using Windows® XP operating system, make sure to install the Windows® XP Service Pack 2 or later versions.

Entering the NVIDIA® MediaShield BIOS RAID utility

To enter the NVIDIA® MediaShield BIOS RAID utility

1. Boot up your computer.
2. During POST, press <F10> to display the main menu of the utility.



The RAID BIOS setup screens shown in this section are for reference only, and may not exactly match the items on your screen.

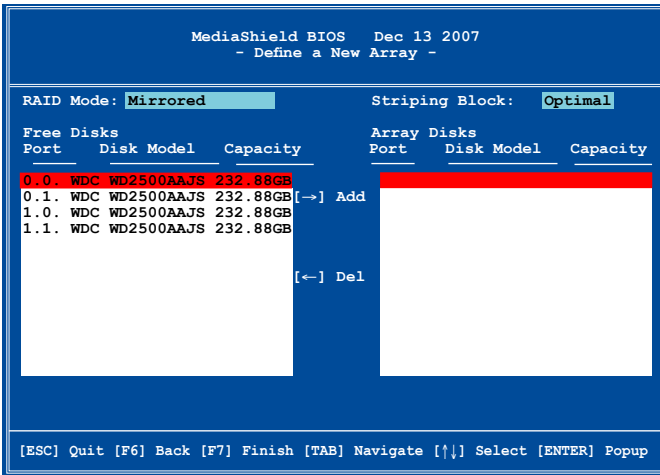

At the bottom of the screen are the navigation keys. These keys allow you to move through and select menu options.

Creating a RAID Volume

To create a RAID volume:

1. From the **Define a New Array** screen, use the <TAB> key to highlight the **RAID Mode** field, and then press <Enter>. The following sub-menu appears. Use the up or down arrow keys to select a RAID mode, and then press <Enter>.

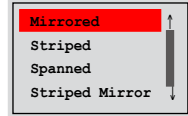

2. Press <TAB> to highlight the **Stripe Block** field, and then press <Enter>. The following sub-menu appears:

Use the up or down arrow keys to select the stripe size for your RAID array, and then press <Enter>. The available values range from 8 KB to 128 KB. The default selection is Optimal. The stripe value should be chosen based on the planned drive usage.

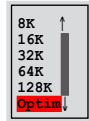

- 8 /16 KB - low disk usage
- 64 KB - typical disk usage
- 128 KB - performance disk usage



- For server systems, we recommend using a lower array block size. For multimedia computer systems used mainly for audio and video editing, we recommend a higher array block size for optimum performance.
- Stripe block size selection is not available for **Mirrored** or **Spanned** RAID arrays.

3. Press <TAB> to highlight the **Free Disks** field. Use the left or right arrow keys to assign the array disks.
4. Press <F7> to create RAID set. The following message box appears.

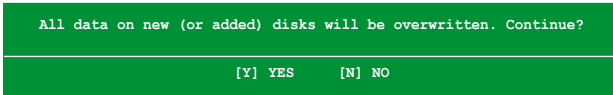

5. Press <Y> to clear the selected disks or <N> to proceed without clearing the disks. The following screen appears.



Take caution in using this option. All data on the RAID drives will be lost!

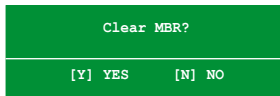

6. Press <Y> to clear the MBR.

The Array List screen appears, where you can review the RAID arrays that you have set up.

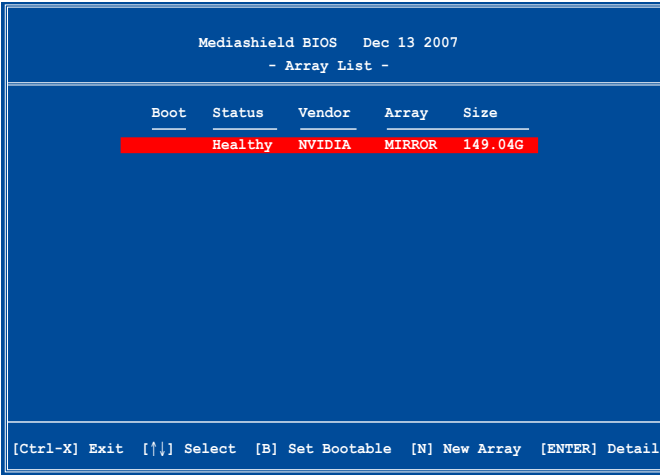

A new set of navigation keys is displayed on the bottom of the screen.

7. Press <Ctrl+X> to save settings and exit.

Rebuilding a RAID array

To rebuild a RAID array

1. From the **Array List** screen, use the up or down arrow keys to select a RAID array, and then press <Enter>. The RAID Array details appear.

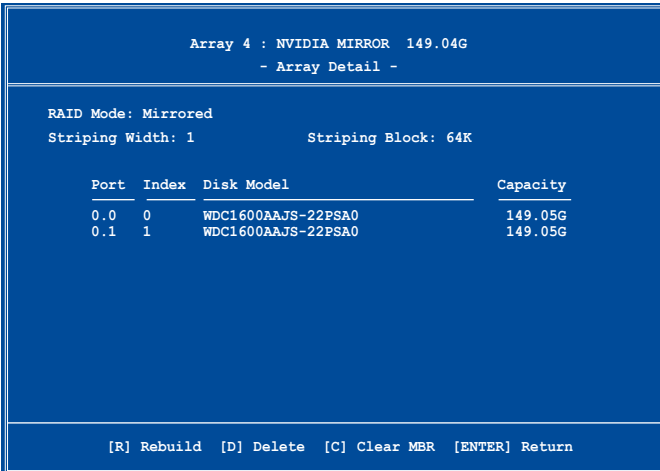

A new set of navigation keys is displayed on the bottom of the screen.

2. Press <R> to rebuild a RAID array. The following screen appears.

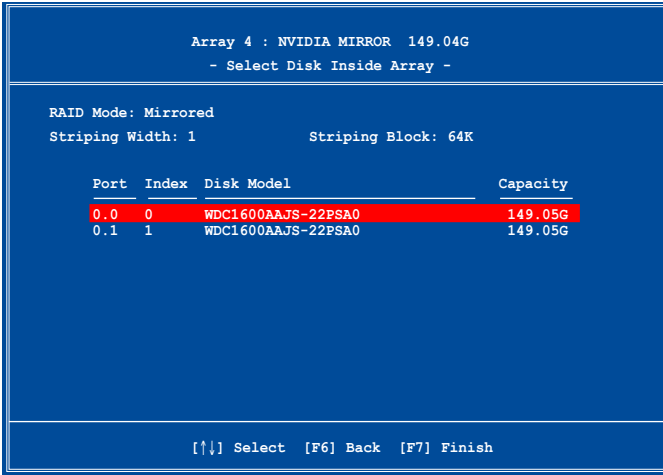

3. Use the up or down arrow keys to select a RAID array to rebuild, then press <F7>. The following confirmation message appears.

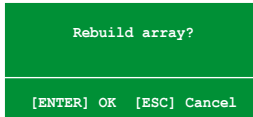

4. Press <Enter> to start rebuilding array or press <Esc> to cancel.
5. After the rebuild process, the Array list menu appears.



You will need to enter Window® XP/Vista and run the NVIDIA utility in order to complete the rebuilt process.

Deleting a RAID array

To delete a RAID array

1. From the **Array List** screen, use the up or down arrow keys to select a RAID array, and then press <Enter>. The RAID Array details appear.

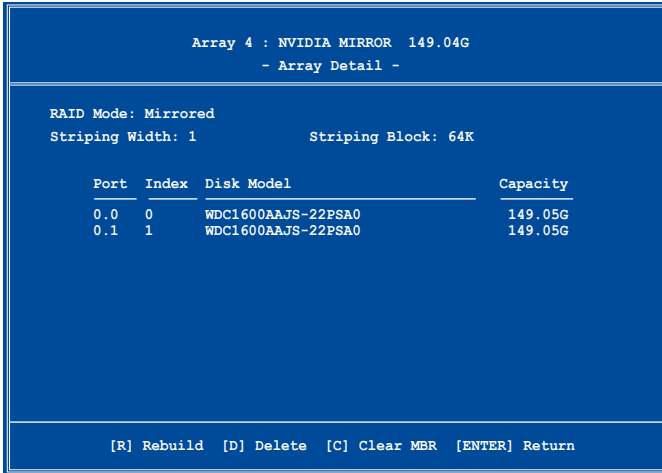

A new set of navigation keys is displayed on the bottom of the screen.

2. Press <D> to delete a RAID array. The following confirmation message appears.

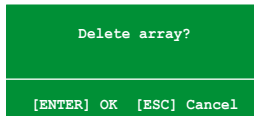

3. Press <Y> to delete array or press <N> to cancel.



Take caution in using this option. All data on the RAID drives will be lost!

4. If you deleted all existing arrays, the **Define a New Array** screen appears again.

Clearing a disk MBR

To clear disk MBR

1. From the **Array List** screen, use the up or down arrow keys to select a RAID array, and then press <Enter>. The RAID Array details appear.

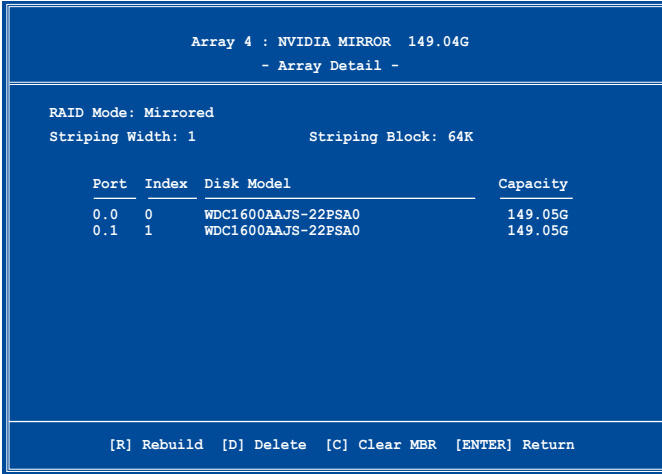

A new set of navigation keys is displayed on the bottom of the screen.

2. Press <C> to clear disk MBR. The following confirmation message appears.

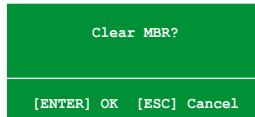

3. Press <Y> to clear the disk MBR or press <N> to cancel.



Take caution in using this option. All data on the RAID drives will be lost!

4.5 Creating a RAID driver disk

A floppy disk with the RAID driver is required when installing Windows® XP/Vista operating system on a hard disk drive that is included in a RAID set.

4.5.1 Creating a RAID driver disk without entering the OS

To create a RAID/SATA driver disk without entering the OS:

1. Boot your computer.
2. Press during POST to enter the BIOS setup utility.
3. Set the optical drive as the primary boot device.
4. Insert the support DVD into the optical drive.
5. Save changes and exit BIOS.
6. Press any key when the system prompts “Press any key to boot from the optical drive.”
7. When the menu appears, press <1> to create a RAID driver disk.
8. Insert a formatted floppy disk into the floppy drive then press <Enter>.
9. Follow succeeding screen instructions to complete the process.

4.5.2 Creating a RAID/SATA driver disk in Windows®

1. Start Windows®.
2. Place the motherboard support DVD into the optical drive.
3. Go to the **Make Disk** menu, and then click **NVIDIA 32/64bit XP SATA RAID Driver** to create a NVIDIA® 32/64 bit XP SATA RAID driver disk.
4. Insert a floppy disk into the floppy disk drive.
5. Follow succeeding screen instructions to complete the process.



Write-protect the floppy disk to avoid computer virus infection.

To install the RAID driver in Windows® XP:

1. During the OS installation, the system prompts you to press the F6 key to install third-party SCSI or RAID driver.
2. Press <F6> then insert the floppy disk with RAID driver into the floppy disk drive.
3. Follow the succeeding screen instructions to complete the installation.

To install the RAID driver in Windows® Vista™:

1. Insert the motherboard support DVD into the optical drive.

Find RAID driver in the support DVD through the path below:

Drivers\Chipset\Disk\RAID

Find AHCI driver in the support DVD through the path below:

Drivers\Chipset\Disk\AHCI

2. Follow the succeeding screen instructions to complete the installation.



Due to chipset limitation, the Serial ATA ports supported by the NVIDIA chipset doesn't support Serial Optical Disk Drives (Serial ODD) under DOS.

This chapter describes the NVIDIA Hybrid SLI™ feature and shows the graphics card installation procedures.

NVIDIA® Hybrid SLI™

technology support

5

5.1 NVIDIA Hybrid SLI Technology 5-1

5.1 NVIDIA® Hybrid SLI® Technology

The motherboard supports the NVIDIA® Hybrid SLI® technology that includes two primary features: GeForce® Boost and HybridPower™. GeForce® Boost enhances the performance of NVIDIA discrete Graphics Process Units (dGPU) when they work with the onboard motherboard GPU (mGPU). HybridPower™ unleashes the graphics performance of the dGPU and enables low-power operation when the performance of the dGPU is not needed. You can switch from the dGPU(s) to the mGPU for a quiet, power-saving computer environment.



- Hybrid SLI technology is supported by Windows® Vista™ only.
- Hybrid SLI technology requires at least 2GB system memory to activate.
- GeForce Boost supports up to two displays simultaneously (both connected to either the mGPU or the dGPU).
- When two or more displays are connected to both the mGPU and the dGPU, the Hybrid SLI mode is disabled and the multi-display mode is enabled. In the multi-display mode, up to four displays can be connected (two displays driven by the mGPU and two displays by the dGPU).
- HybridPower requires displays to be connected to the mGPU. HybridPower cannot be enabled when displays are driven through the dGPU.
- HybridPower and GeForce Boost are supported by certain set of dGPUs. Go to www.nvidia.com/hybridсли to learn the supported GPUs.

5.1.1 System requirements

Before using Hybrid SLI, make sure if your system meets the following requirements:

For best GeForce Boost performance

- AMD Phenom 9600 CPU (operating at 1800Mhz or higher)
- 2 x 1024MB of DDR2-800 DRAM
- Discrete GPU recommended for GeForce Boost
- At least 256MB of Frame Buffer carve out for the motherboard GPU

For best HybridPower benefits

- AMD Athlon X2 3800+ CPU (operating at 1800Mhz or higher)
- 2 x 1024MB of DDR2-667 DRAM
- Discrete GPU recommended for HybridPower
- At least 256MB of Frame Buffer carve out for the motherboard GPU

5.1.2 Enabling GeForce® Boost and HybridPower™



Before enabling GeForce Boost and HybridPower, make sure that you have installed a dGPU recommended for GeForce Boost on your motherboard.

GeForce Boost

1. Turn on the system and press during the Power-On Self-Test (POST) to enter the BIOS Setup Utility.
2. Go to **Advanced > Chipset** and set the **Hybrid Support** item to [Auto]. See section **3.4.4 Chipset** for details.



The **Hybrid Support** item becomes user-configurable only when a dGPU is detected. Make sure that your dGPU is properly installed.

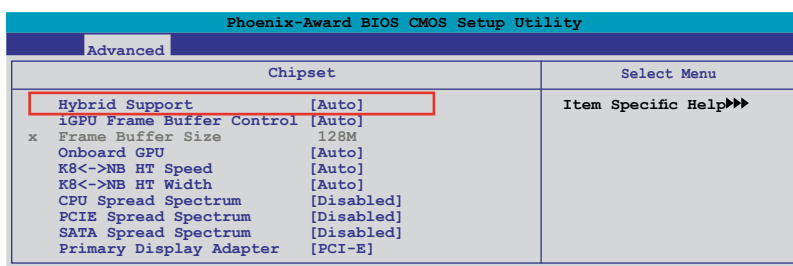

3. Save your changes and Exit Setup.
4. Place the motherboard support DVD into the optical drive, and go to the **Drivers** menu to install the **NVIDIA Chipset Driver Program**.
5. Restart the system.
6. If the driver is correctly installed, you will find the Hybrid SLI icon on the taskbar.

The Hybrid SLI icon indicates that the system is in Performance mode and that GeForce Boost is enabled. The onboard GPU will share the rendering load with the dGPU and boost the performance of the dGPU.





Visit www.asus.com for the latest chipset driver.

To enable HybridPower

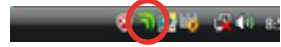
1. Follow Step 1 to 5 on the previous page to complete the hardware and driver installation.
2. If the driver is correctly installed, you will find the Hybrid SLI icon on the taskbar.



The Hybrid SLI icon indicates that the system is in Performance mode and that rendering is being done by the dGPU. The mGPU is being used only to drive the display.

3. Click the Hybrid SLI icon and select **Save Power**.
4. The icon will change state (from  to ) to indicate that the system is in Power Saving mode, which means that the dGPU is turned off and the mGPU is both rendering and displaying.

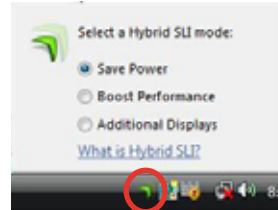

5. When the Power Saving mode is enabled, the dGPU does not show in the Windows® Device Manager.

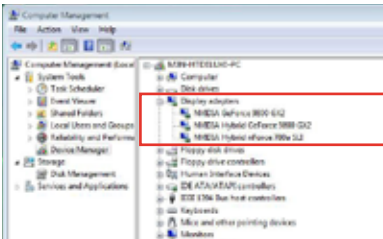

Power Saving mode is disabled.

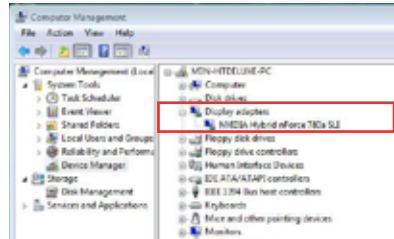

When the Power Saving mode is enabled, the dGPU is turned off and does not appear in the Device Manager.

